

PHAROS



Modular-Design Industrial-Grade Femtosecond Lasers

FEATURES

- 190 fs – 20 ps tunable pulse duration
- 2 mJ maximum pulse energy
- 20 W maximum output power
- Single-shot – 1 MHz repetition rate
- Pulse picker for pulse-on-demand mode
- Industrial-grade design
- Optional automated harmonic generator
- Optional CEP stabilization
- Optional repetition rate locking to an external source



PHAROS is a series of femtosecond lasers combining millijoule pulse energy and high average power. PHAROS features a mechanical and optical design optimized for both scientific and industrial applications. A compact, thermally-stabilized, and sealed design enables PHAROS integration into various optical setups and machining workstations. Diode-pumped Yb medium significantly reduces maintenance costs and provides a long laser lifetime, while the robust optomechanical design enables stable operation in varying environments.

The tunability of PHAROS allows the system to cover applications normally requiring multiple different laser systems. Tunable parameters include pulse duration (190 fs – 20 ps), repetition rate (single-shot – 1 MHz), pulse energy (up to 2 mJ), and average power (up to 20 W). A pulse-on-demand mode is available using the built-in pulse picker. The versatility of PHAROS can be extended by a variety of optional modules.

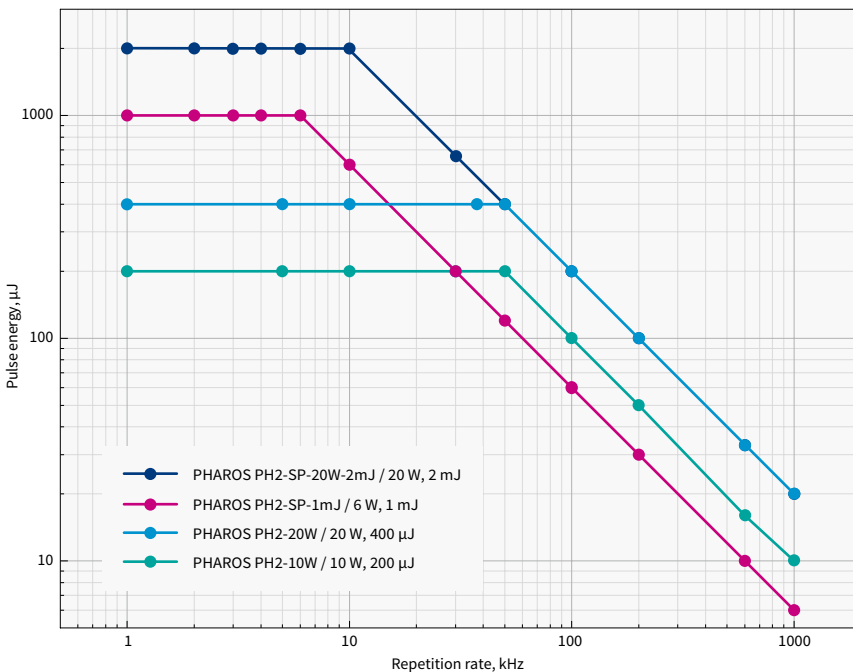

Pulse energy vs fundamental repetition rate of PHAROS

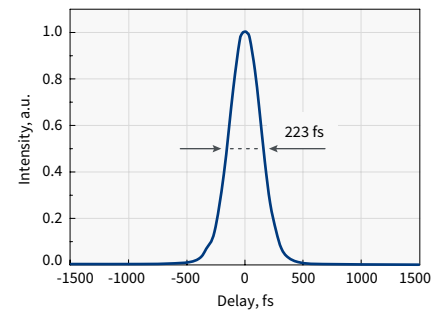

Typical pulse duration of PHAROS

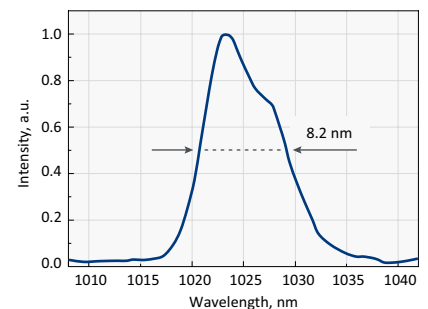

Typical spectrum of PHAROS

SPECIFICATIONS

Model ¹⁾	PH2-10W	PH2-15W	PH2-20W	PH2-SP-1mJ	PH2-SP-20W-2mJ
---------------------	---------	---------	---------	------------	----------------

OUTPUT CHARACTERISTIC

Maximum output power	10 W	15 W	20 W	10 W	20 W
Pulse duration ²⁾	< 290 fs			< 190 fs	
Pulse duration tuning range	290 fs – 10 ps (20 ps on request)			190 fs – 10 ps (20 ps on request)	
Maximum pulse energy	0.4 mJ			1 mJ	2 mJ
Repetition rate	Single-shot – 1 MHz				
Pulse selection	Single-shot, pulse-on-demand, any fundamental repetition rate division				
Center wavelength ³⁾	1030 ± 10 nm				
Polarization	Linear, horizontal				
Beam quality	TEM ₀₀ ; M ² < 1.2			TEM ₀₀ ; M ² < 1.3	
Beam diameter ⁴⁾	2.5 mm			2.9 mm	4.3 mm
Pulse-to-pulse energy stability ⁵⁾	RMS deviation ⁶⁾ < 0.5% over 24 h				
Long-term power stability	RMS deviation ⁶⁾ < 0.5% over 100 h				
Beam pointing stability	< 20 μrad/°C				
Pre-pulse contrast	< 1 : 1000				
Post-pulse contrast	< 1 : 200				

OPTIONAL EXTENSIONS

Oscillator output	Optional. Contact sales@lightcon.com for more details or customized solutions				
Typical output	1 – 6 W, 50 – 250 fs, ≈ 1035 nm, ≈ 76 MHz; available simultaneously				
Harmonic generator	Integrated, optional (see page 8)				
Output wavelength	515 nm, 343 nm, 257 nm, or 206 nm				
Optical parametric amplifier	Integrated, optional (see page 15)				
Tuning range	320 – 10000 nm				
BiBurst option	Tunable GHz and MHz burst with burst-in-burst capability, optional (see page 9)				
GHz-Burst					
Intra burst pulse period ⁷⁾	200 ± 40 ps				
Number of pulses, P ⁸⁾	1 ... 25				
MHz-Burst					
Intra burst pulse period	≈ 15 ns				
Number of pulses, N	1 ... 9 (7 with FEC)				

PHYSICAL DIMENSIONS

Laser head (L × W × H) ⁹⁾	780 × 419 × 230 mm
Chiller (L × W × H)	590 × 484 × 267 mm
24 V DC power supply (L × W × H) ⁹⁾	280 × 144 × 49 mm

ENVIRONMENTAL & UTILITY REQUIREMENTS

Operating temperature	15 – 30 °C (air conditioning recommended)
Relative humidity	< 80% (non-condensing)
Electrical requirements	100 – 240 V AC, 50 – 60 Hz, 20 – 10 A
Rated power	1000 W
Power consumption	600 W
Electrical requirements (chiller)	100 – 230 V AC, 50 – 60 Hz
Rated power (chiller)	1400 W
Power consumption (chiller)	1000 W

¹⁾ More models are available on request.

²⁾ Assuming Gaussian pulse shape.

³⁾ Precise wavelengths for specific models are available on request.

⁴⁾ FWHM, measured at laser output, using maximum pulse energy.

⁵⁾ Under stable environmental conditions.

⁶⁾ Normalized to average pulse energy, NRMSD.

⁷⁾ Custom spacing is available on request.

⁸⁾ Maximum number of pulses in a burst depends on the laser repetition rate. Custom number of pulses are available on request.

⁹⁾ Dimensions might increase for the lasers with integrated optional modules.

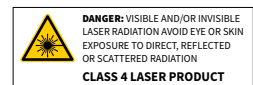

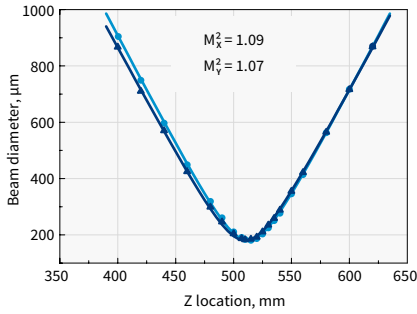

Typical M^2 measurement data of PHAROS

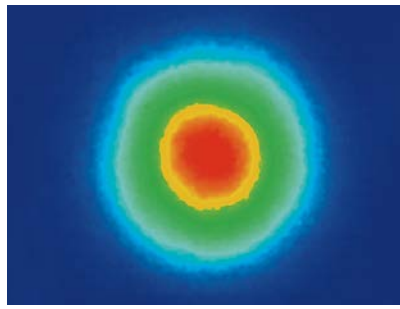

Typical near-field beam profile of PHAROS at 200 kHz

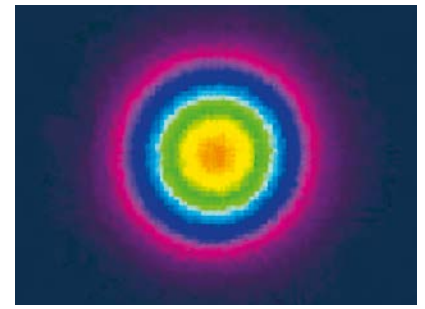

Typical far-field beam profile of PHAROS at 200 kHz

STABILITY MEASUREMENTS

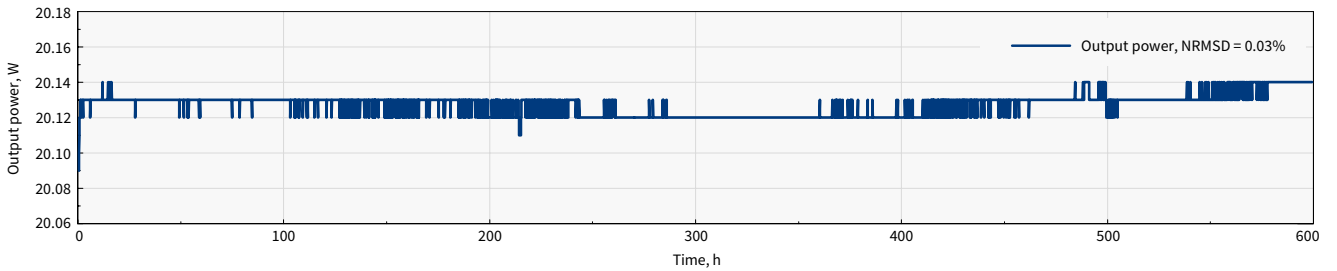

Long-term power stability of PHAROS

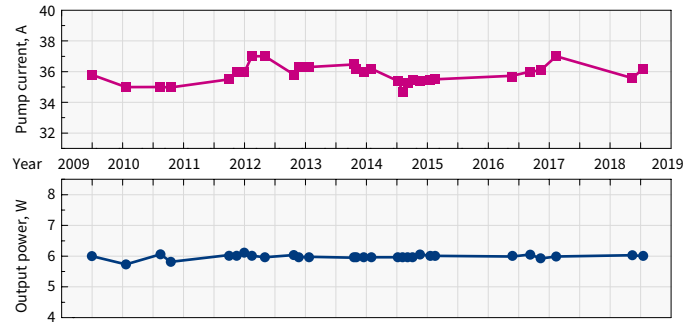
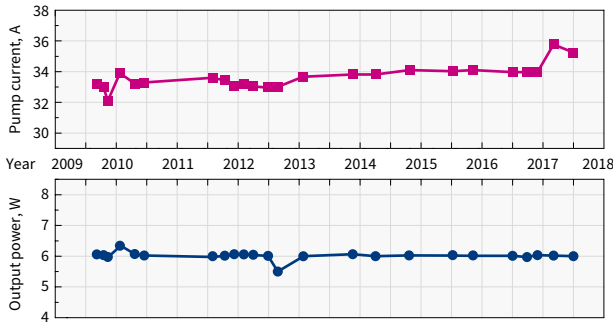

Output power of industrial-grade PHAROS lasers operating 24/7 and current of pump diodes during the years

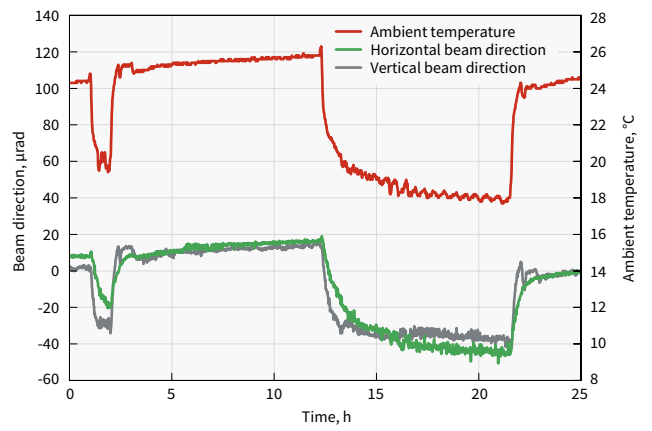
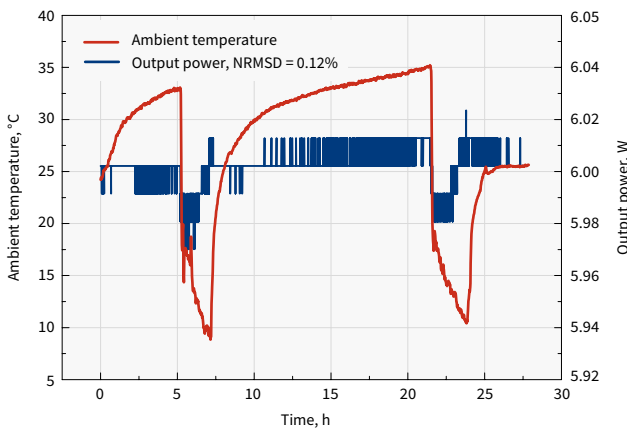

PHAROS output power and beam direction with power lock enabled, under harsh environmental conditions

CEP STABILIZATION

PHAROS lasers can be equipped with feedback electronics for carrier-envelope phase (CEP) stabilization of the output pulses. The carrier-envelope offset (CEO) of the PHAROS oscillator is actively locked to 1/4th of the repetition rate with a < 100 mrad standard deviation. The CEP stable pulses

from the synchronized amplifier have a < 350 mrad standard deviation. The CEP drift occurring inside the amplifier and the user's setup can be compensated with an out of loop f-2f interferometer, which is a part of the complete PHAROS active CEP stabilization package.

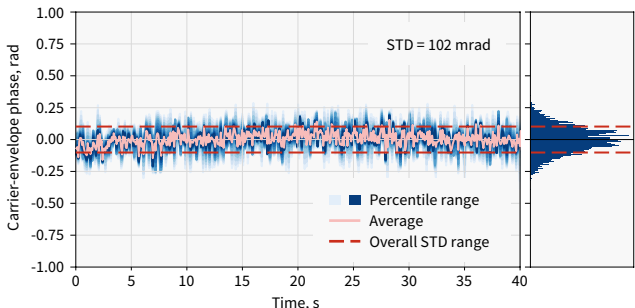

Short-term CEP stability of PHAROS operating at 200 kHz repetition rate

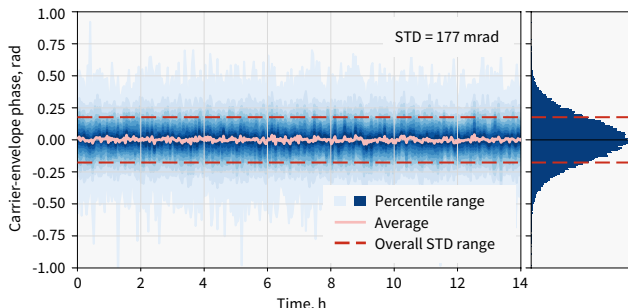

Long-term CEP stability of PHAROS operating at 200 kHz repetition rate

REPETITION RATE LOCKING

The oscillator of PHAROS laser can be customized for repetition rate locking applications. Coupled with the necessary feedback electronics, the repetition rate is synchronized to an external RF source using the two piezo stages installed inside the cavity.

The repetition rate locking system can assure an integrated timing jitter of less than 200 fs for RF reference frequencies larger than 500 MHz. Continuous phase shifting is available on request.

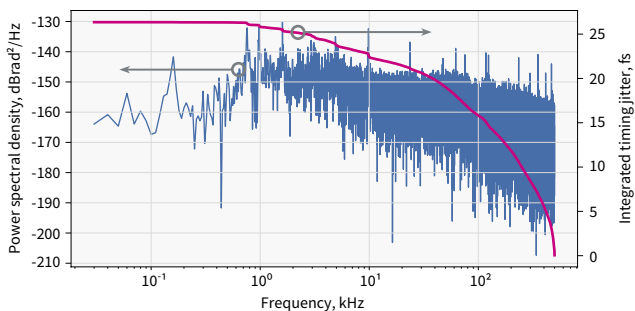

Phase noise data of PHAROS oscillator locked to a 2.8 GHz RF source

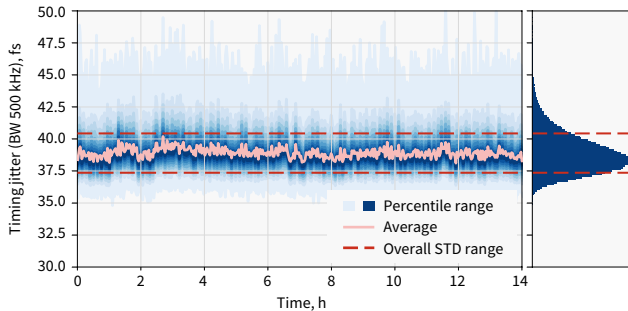

Timing jitter stability over 14 h; PHAROS oscillator locked to a 2.8 GHz RF source

DRAWINGS

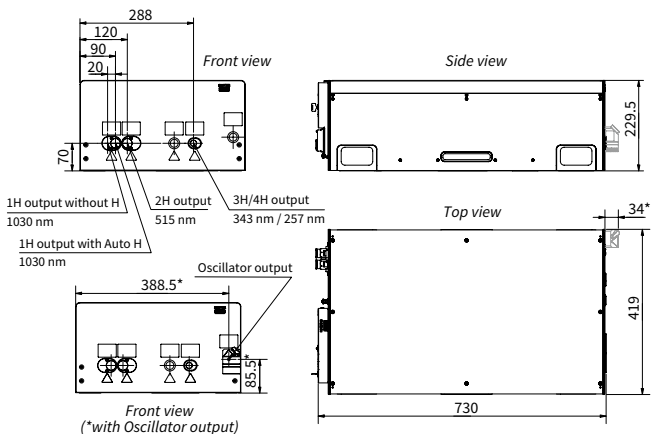

PHAROS-PH2 laser PH2-730 housing drawing