

# PHAROS



## Modular-Design Femtosecond Lasers for Industry and Science

### FEATURES

- Tunable pulse duration, 100 fs – 20 ps
- Maximum pulse energy of up to 4 mJ
- Down to < 100 fs right at the output
- Pulse-on-demand and BiBurst for pulse control
- Up to 5<sup>th</sup> harmonic or tunable extensions
- CEP stabilization or repetition rate locking
- Thermally-stabilized and sealed design



PHAROS is a series of femtosecond lasers combining multi-millijoule pulse energy and high average power. PHAROS features a mechanical and optical design optimized for both scientific and industrial applications. A compact, thermally-stabilized, and sealed design enables PHAROS integration into various optical setups and machining workstations. The robust optomechanical design provides an exceptional laser lifetime and stable operation in varying environments.

The tunability of PHAROS allows the system to cover applications normally requiring multiple different laser systems. Tunable parameters include pulse duration (100 fs – 20 ps), repetition rate (single-shot – 1 MHz), pulse energy (up to 4 mJ), and average power (up to 20 W). A pulse-on-demand mode is available using the built-in pulse picker. The versatility of PHAROS can be extended by a variety of options, including carrier-envelope phase (CEP) stabilization, repetition rate locking to an external source, automated harmonic modules and optical parametric amplifiers.

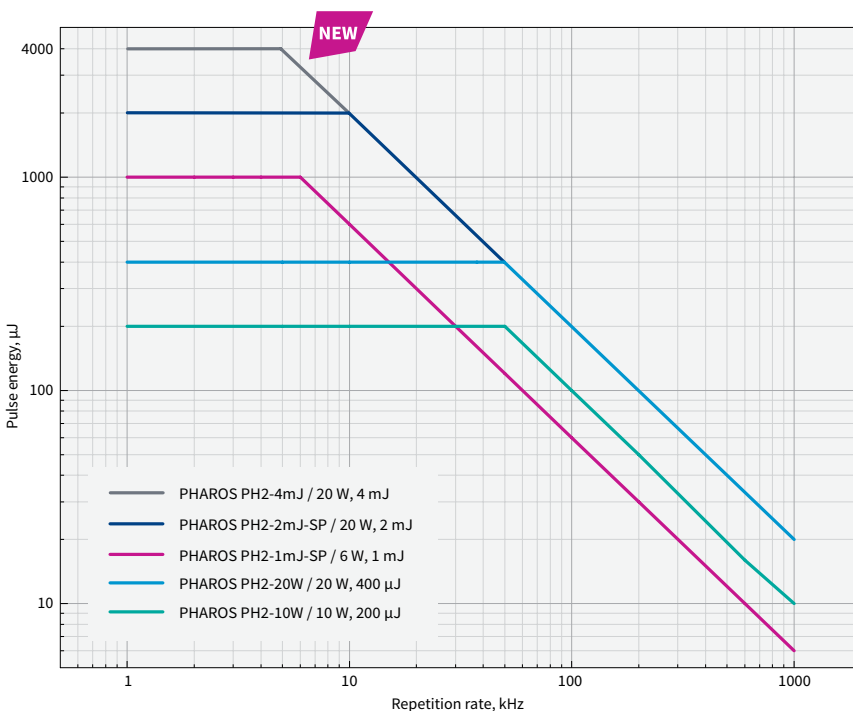

Pulse energy vs fundamental repetition rate of PHAROS

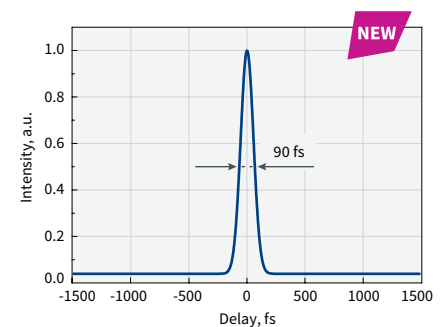

Typical pulse duration of PHAROS-PH2-UP

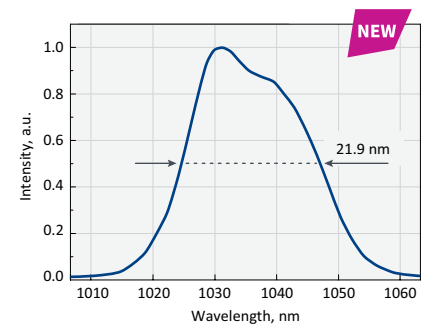

Typical spectrum of PHAROS-PH2-UP

# SPECIFICATIONS

Model	PH2-10W	PH2-20W	PH2-4mJ <span style="background-color: #e91e63; color: white; padding: 2px;">NEW</span>	PH2-1mJ-SP	PH2-2mJ-SP	PH2-UP <span style="background-color: #e91e63; color: white; padding: 2px;">NEW</span>
-------	---------	---------	---	------------	------------	--

## OUTPUT CHARACTERISTIC

Center wavelength <sup>1)</sup>	1030 ± 10 nm					
Maximum output power	10 W	20 W		10 W	20 W	10 W / 20 W
Pulse duration <sup>2)</sup>	< 290 fs		< 450 fs <sup>3)</sup>	< 190 fs		< 100 fs
Pulse duration tuning range	290 fs – 10 ps (20 ps on request)		450 fs – 10 ps	190 fs – 10 ps (20 ps on request)		100 fs – 10 ps
Maximum pulse energy	0.2 mJ / 0.4 mJ		4 mJ	1 mJ	2 mJ	0.2 mJ / 0.4 mJ
Repetition rate	Single-shot – 1 MHz					
Pulse selection	Single-shot, pulse-on-demand, any fundamental repetition rate division					
Polarization	Linear, horizontal					
Beam quality, M <sup>2</sup>	< 1.2		< 1.3			< 1.2
Beam diameter <sup>4)</sup>	3.3 ± 0.4 mm / 4 ± 0.4 mm		6.6 ± 0.7 mm	4.5 ± 0.5 mm	6.6 ± 0.7 mm	4.5 ± 0.5 mm
Beam pointing stability	< 20 μrad/°C					
Pre-pulse contrast	< 1 : 1000					
Post-pulse contrast	< 1 : 200					
Pulse-to-pulse energy stability, 24 h <sup>5)</sup>	< 0.5%					
Long-term power stability, 100h <sup>5)</sup>	< 0.5%					

## MAIN OPTIONS

Oscillator output	1 – 6 W, 50 – 250 fs, ≈ 1035 nm, ≈ 76 MHz <sup>6)</sup>					
Harmonic generator <sup>7)</sup>	515 nm, 343 nm, 257 nm, or 206 nm; see page 22					
Optical parametric amplifier <sup>8)</sup>	320 – 10000 nm; see page 30					
BiBurst option	Tunable GHz and MHz burst with burst-in-burst capability; see page 17					
CEP stabilization	See page 9					
Repetition rate locking						

## PHYSICAL DIMENSIONS

Laser head (L × W × H) <sup>9)</sup>	730 × 419 × 230 mm	843 × 492 × 250 mm	730 × 419 × 230 mm
Chiller (L × W × H)	590 × 484 × 267 mm		
24 V DC power supply (L × W × H) <sup>9)</sup>	280 × 144 × 49 mm		

## ENVIRONMENTAL & UTILITY REQUIREMENTS

Operating temperature	15 – 30 °C (air conditioning recommended)		
Relative humidity	< 80% (non-condensing)		
Electrical requirements	Laser	100 V AC, 12 A – 240 V AC, 5 A, 50 – 60 Hz	
	Chiller	100 – 230 V AC, 50 – 60 Hz	
Rated power	Laser	1000 W	
	Chiller	1400 W	
Power consumption	Laser	600 W	
	Chiller	1000 W	

<sup>1)</sup> Precise wavelengths for specific models are available on request.

<sup>2)</sup> Assuming Gaussian pulse shape.

<sup>3)</sup> Pulse duration can be reduced to < 250 fs if pulse peak intensity of > 50 GW/cm<sup>2</sup> is tolerated by customer setup.

<sup>4)</sup> FW 1/e<sup>2</sup>, measured at laser output, using maximum pulse energy.

<sup>5)</sup> Under stable environmental conditions. Expressed as NRMSD (normalized root mean squared deviation).

<sup>6)</sup> Available simultaneously. Contact sales@lightcon.com for details or customized solutions.

<sup>7)</sup> Integrated. For external harmonic generator, refer to HIRO.

<sup>8)</sup> Integrated. For more options and OPAs for -4mJ and -UP models, refer to ORPHEUS series of OPAs.

<sup>9)</sup> Dimensions depend on laser configuration and integrated options.

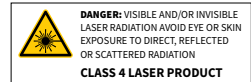

## BEAM PROPERTIES

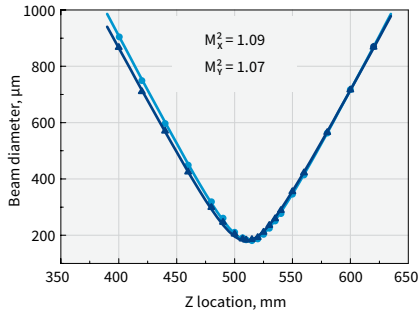

Typical  $M^2$  measurement data of PHAROS

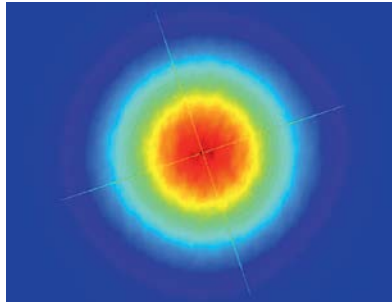

Typical near-field beam profile of PHAROS

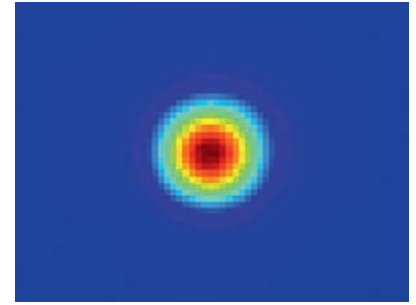

Typical far-field beam profile of PHAROS

## STABILITY MEASUREMENTS

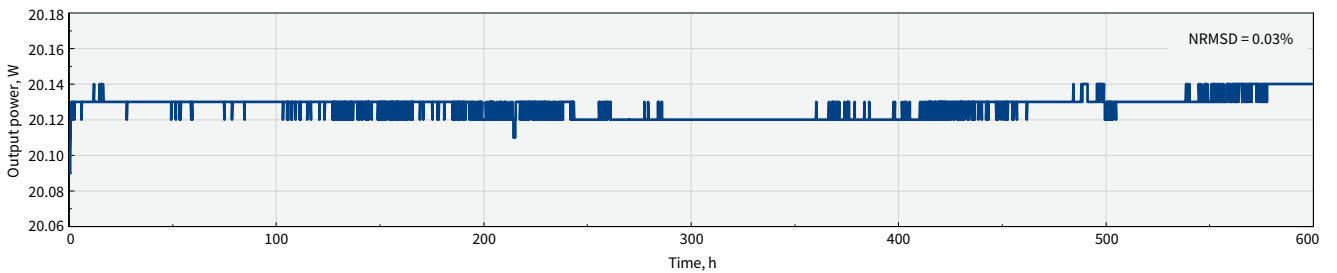

Long-term power stability of PHAROS

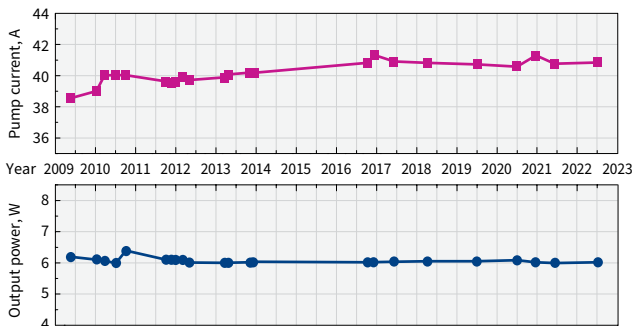

Output power of industrial-grade PHAROS lasers operating 24/7 and current of pump diodes during the years

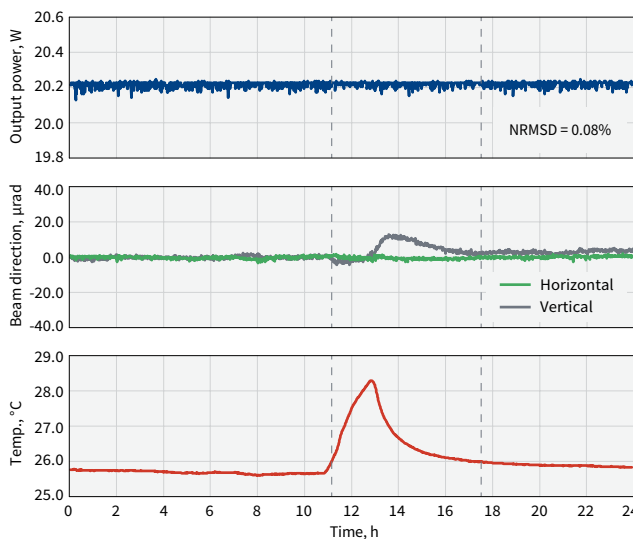
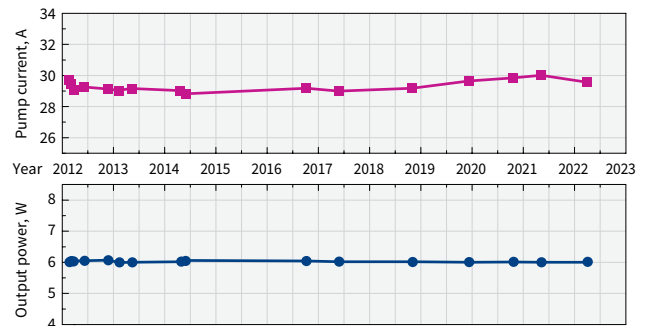

PHAROS output power and beam direction with power lock enabled, under varying environmental conditions

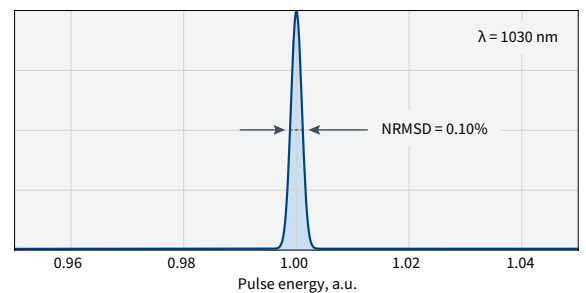

Typical pulse-to-pulse energy stability

## CEP STABILIZATION

PHAROS lasers can be equipped with feedback electronics for carrier-envelope phase (CEP) stabilization of the output pulses. The carrier-envelope offset (CEO) of the PHAROS oscillator is actively locked to 1/4<sup>th</sup> of the repetition rate with a < 100 mrad standard deviation. The CEP stable pulses

from the synchronized amplifier have a < 350 mrad standard deviation. The CEP drift occurring inside the amplifier and the user's setup can be compensated with an out of loop f-2f interferometer, which is a part of the complete PHAROS active CEP stabilization package.

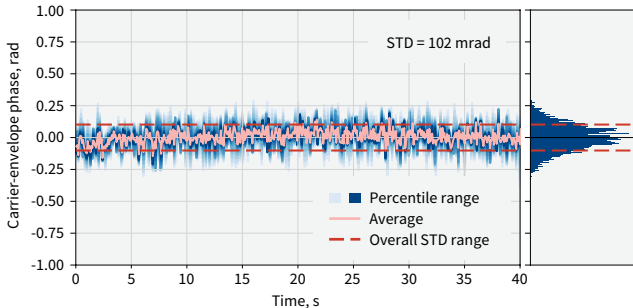

Short-term CEP stability of PHAROS operating at 200 kHz repetition rate

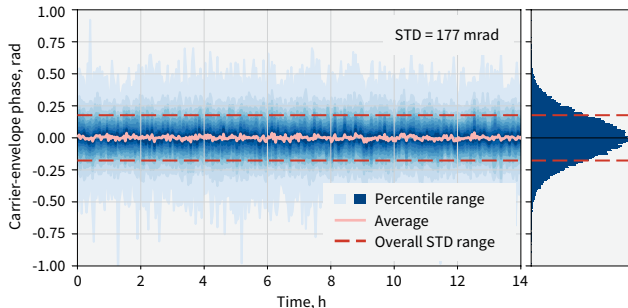

Long-term CEP stability of PHAROS operating at 200 kHz repetition rate

## REPETITION RATE LOCKING

The oscillator of PHAROS laser can be customized for repetition rate locking applications. Coupled with the necessary feedback electronics, the repetition rate is synchronized to an external RF source using the two piezo stages installed inside the cavity.

The repetition rate locking system can assure an integrated timing jitter of less than 200 fs for RF reference frequencies larger than 500 MHz. Continuous phase shifting is available on request.

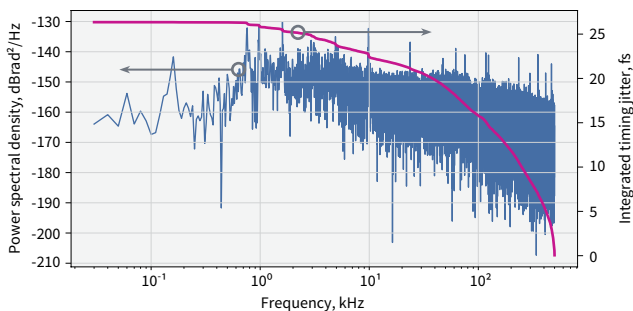

Phase noise data of PHAROS oscillator locked to a 2.8 GHz RF source

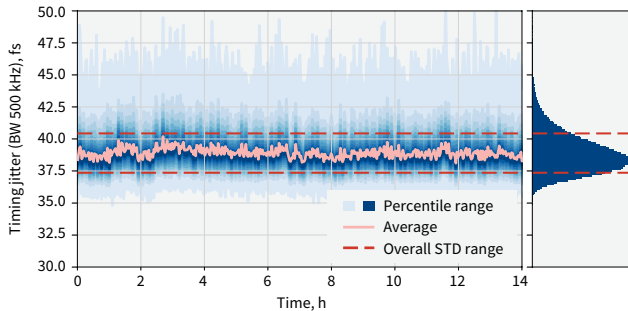

Timing jitter stability over 14 h; PHAROS oscillator locked to a 2.8 GHz RF source

## DRAWINGS

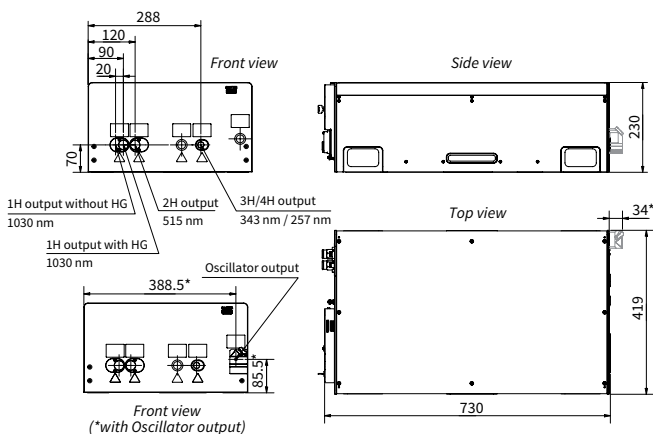

PHAROS-PH2 / PH2-UP drawing

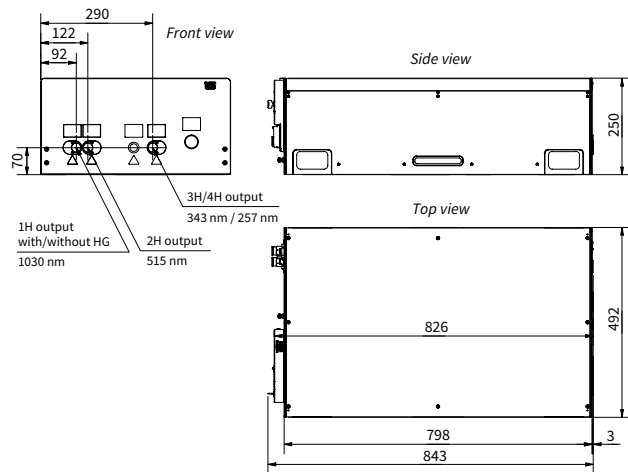

PHAROS-PH2-4mJ drawing