

I-OPA

Industrial-Grade Optical Parametric Amplifier

FEATURES

- Wavelength tunability in an industrial design
- Single-box solution
- Tunable or fixed-wavelength models
- Plug-and-play installation and robust performance
- The most compact OPA in the market



I-OPA-TW on air-cooled CARBIDE-CB5

The industrial-grade optical parametric amplifier I-OPA series marks a new era of simplicity in the world of wavelength-tunable femtosecond sources. Based on decades of experience with optical parametric amplifiers, this solution combines wavelength tunability with robust industrial design. The I-OPA is a rugged module integrated into our PHAROS or CARBIDE lasers, providing stability comparable to that of industrial harmonic generators. The sealed design provides mechanical stability and eliminates the effects of air turbulence, minimizing energy fluctuations and ensuring stable long-term performance.

The tunable I-OPA provides a wide tuning range and is primarily intended for spectroscopy and microscopy applications. In particular, the -HP model is targeted to be coupled with our HARPIA spectroscopy system as a pump beam source for ultrafast pump-probe spectroscopy. The -F model is primarily designed as a light source for multiphoton microscopy, the -ONE model – for IR spectroscopy, and other applications where high-energy MIR pulses are desired. All models can also be used for micromachining and other industrial applications. The fixed-wavelength I-OPA is a cost-effective solution when a single wavelength is desired.

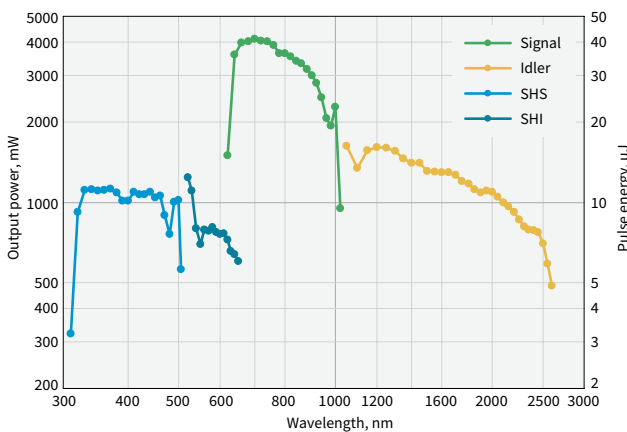

Typical I-OPA-TW-HP tuning curves.
Pump: 40 W, 400 µJ, 100 kHz

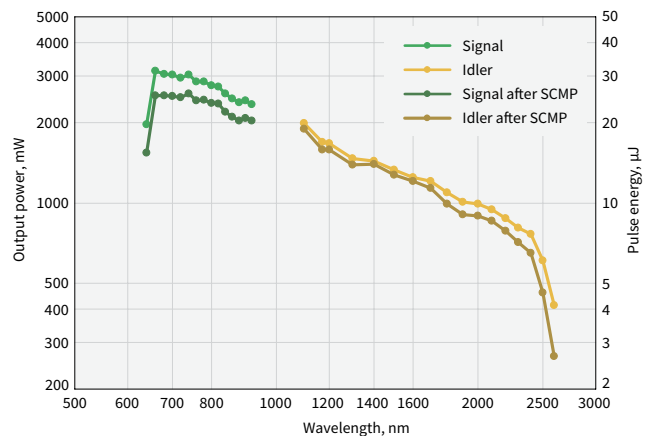

Typical I-OPA-TW-F tuning curves.
Pump: 40 W, 400 µJ, 100 kHz

SPECIFICATIONS

Model	I-OPA-HP	I-OPA-F	I-OPA-ONE
Configuration	ORPHEUS	ORPHEUS-F	ORPHEUS-ONE
Pump power	Up to 40 W		
Pump pulse energy	20 – 400 μ J		
Repetition rate	Up to 2 MHz		
Tuning range ¹⁾	640 – 1010 nm (Signal) 1050 – 2600 nm (Idler)	650 – 920 nm (Signal) 1200 – 2500 nm (Idler)	1350 – 2000 nm (Signal) 2100 – 4500 nm (Idler)
Conversion efficiency	> 7% @ 700 nm (40 – 400 μ J pump; up to 1 MHz)		> 9% @ 1550 nm (40 – 400 μ J pump; up to 1 MHz)
	> 3.5% @ 700 nm (20 – 40 μ J pump; up to 2 MHz)		> 6% @ 1550 nm (20 – 40 μ J pump; up to 2 MHz)
Spectral bandwidth ²⁾	80 – 220 cm^{-1} @ 700 – 960 nm	200 – 1000 cm^{-1} @ 650 – 920 nm 150 – 1000 cm^{-1} @ 1200 – 2000 nm	60 – 150 cm^{-1} @ 1450 – 2000 nm
Pulse duration ²⁾³⁾	120 – 250 fs	< 55 fs @ 800 – 920 nm < 70 fs @ 650 – 800 nm < 100 fs @ 1200 – 2000 nm	100 – 300 fs
Long-term power stability, 8 h ⁴⁾	< 1% @ 800 nm		< 1% @ 1550 nm
Pulse-to-pulse energy stability, 1 min ⁴⁾	< 1% @ 800 nm		< 1% @ 1550 nm
Wavelength extension options	320 – 505 nm (SHS) ⁵⁾ 525 – 640 nm (SHI) ⁵⁾	Contact sales@lightcon.com	4500 – 10000 nm (DFG) ⁶⁾
Pulse compression options ²⁾	n/a	SCMP (Signal pulse compressor) ICMP (Idler pulse compressor) GDD-CMP (Compressor with GDD control)	n/a

- ¹⁾ In case of fixed wavelength (FW), a single wavelength can be selected from the Signal or Idler range. Signal may have accessible Idler pair, and vice versa.
- ²⁾ I-OPA-F broad-bandwidth pulses are compressed externally. Typical pulse duration before compression: 120 – 250 fs, after compression: 25 – 70 fs @ 650 – 920 nm, 40 – 100 fs @ 1200 – 2000 nm.
- ³⁾ Output pulse duration depends on the selected wavelength and pump laser pulse duration.
- ⁴⁾ Expressed as NRMSD (normalized root mean squared deviation).
- ⁵⁾ Conversion efficiency is 1.2% at peak; specified as the percentage of pump power.
- ⁶⁾ Up to 16 μ m tuning range is accessible with an external difference frequency generator.

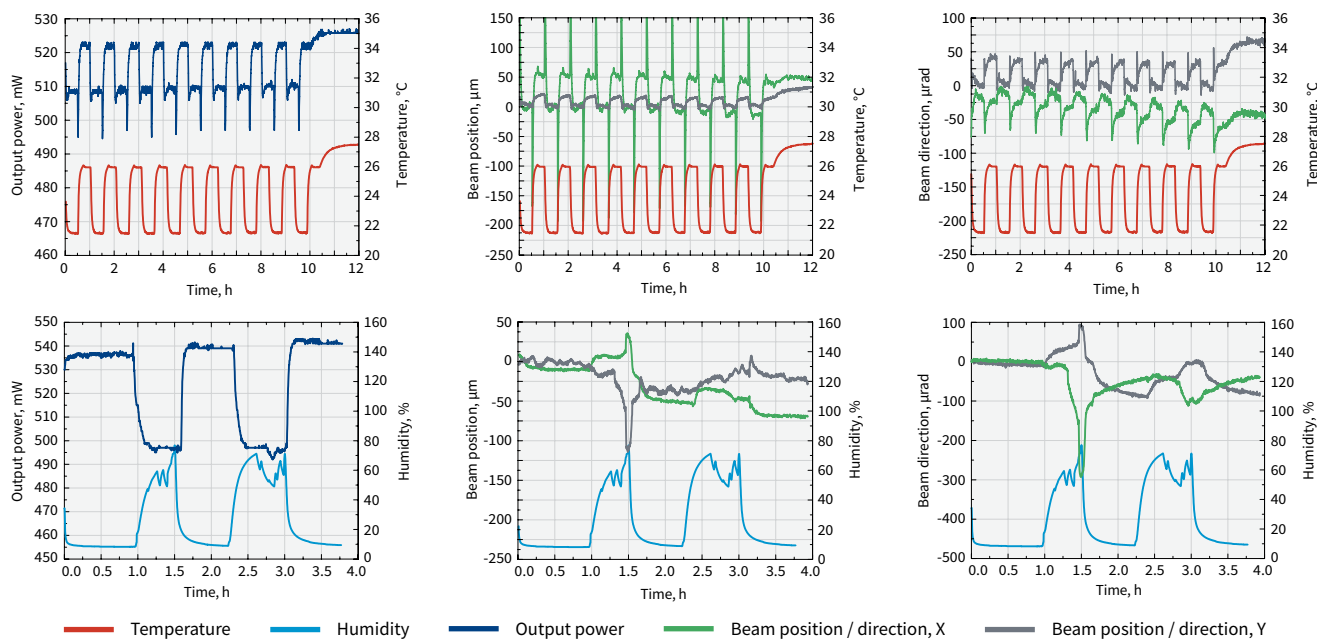
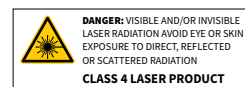

I-OPA output power, beam position, and beam direction under harsh environmental conditions

DRAWINGS

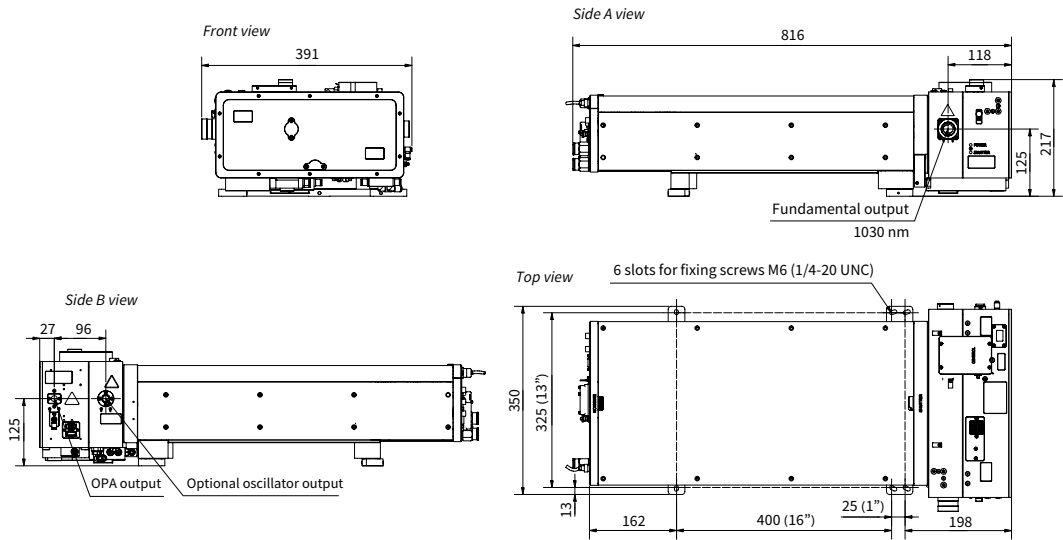

Drawing and output ports of CARBIDE-CB3 with wavelength-tunable/fixed I-OPA-HP

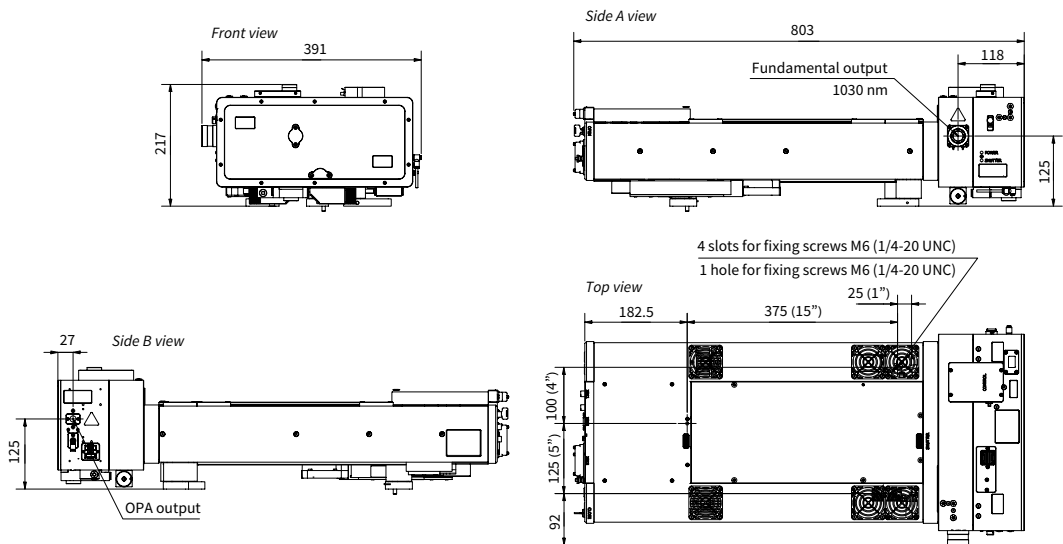

Drawing and output ports of CARBIDE-CB5 with wavelength-tunable/fixed I-OPA-HP

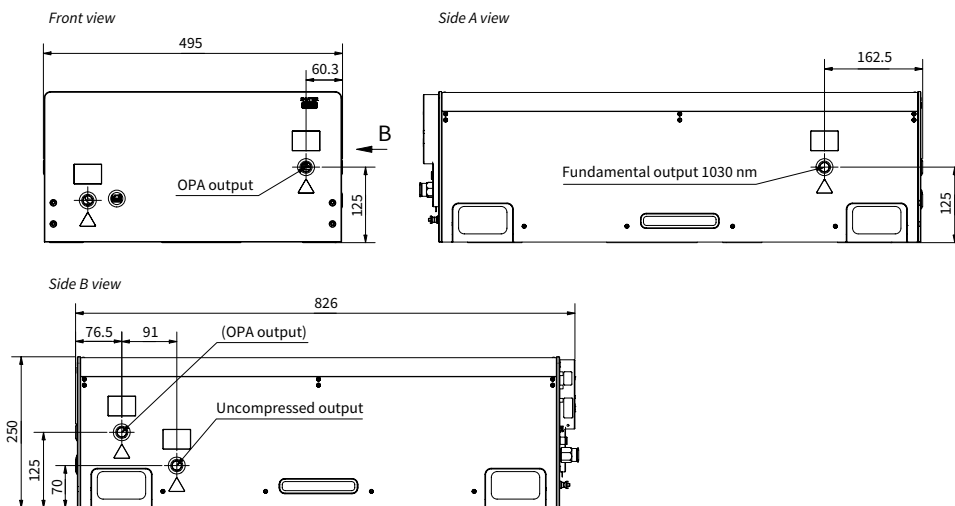

Drawing and output ports of PHAROS-PH2 with wavelength-tunable/fixed I-OPA-HP