

Femtosecond Lasers for Industry

Product Catalog



LIGHT CONVERSION is a global leader in ultrafast technology, designing and manufacturing:

- > Femtosecond Lasers,
- > Wavelength-Tunable Sources,
- > OPCPA Systems,
- > Microscopy Sources,
- > Spectroscopy Systems.

The comprehensive portfolio represents the best-in-class lasers tailored for industry, science, and medicine.

About Us

Founded in 1994, LIGHT CONVERSION has evolved into a leading company in ultrafast laser technology with over 9000 systems installed worldwide and 600 employees, 15% of whom focus on R&D. The company's lasers are used in all of the top 50 universities worldwide, highlighting its commitment to state-of-the-art research, while also ensuring the reliability and performance in 24/7 industrial applications. With international offices in the US, China, and Korea, along with a global representative network, the company ensures worldwide sales and service.

Contents

5 Femtosecond Lasers

CARBIDE

- 6 Unibody-Design Femtosecond Lasers for Industry and Science
- 10 High-Power UV Femtosecond Lasers
- 12 Scientific Interface Module
- 13 BiBurst Option
- 22 Automated Harmonic Generators
- 24 HIRO External Harmonic Generator

PHAROS

- 14 Modular-Design Femtosecond Lasers for Industry and Science
- 13 BiBurst Option
- 23 Automated Harmonic Generators
- 24 HIRO External Harmonic Generator

FLINT

- 18 High-Repetition-Rate Lasers
- 21 Automated Second Harmonic Generator
- 24 HIRO External Harmonic Generator

26 Wavelength-Tunable Sources

I-OPA

29 Micromachining Applications

34 Global Representative Network





Femtosecond Lasers

LIGHT CONVERSION is world-renowned for its industrial-grade Yb-based femtosecond lasers, covering a wide range of scientific, industrial, and medical applications.

CARBIDE

Compact industrial design in air-cooled and water-cooled models, providing up to 120 W, 1 mJ or 80 W, 2 mJ with excellent output stability.

PHAROS

Scientific flexibility and process-tailored output parameters, providing pulse duration down to 100 fs and pulse energy of up to 4 mJ.

FLINT

Expanding the parameter range with repetition rates ranging from 10 to 100 MHz, with power up to 20 W and pulse duration down to 50 fs.

High average power and high pulse energy at a high repetition rate

Market-proven industrial-grade stability and reliability

Tailored to the needs of industry and science

Unibody-Design Femtosecond Lasers for Industry and Science



CARBIDE-CB3

Tunable pulse duration,
190 fs – 20 ps

Maximum output of
120 W, 1 mJ or 80 W, 2 mJ

Single-shot – 10 MHz
repetition rate

NEW

Pulse-on-demand and
BiBurst for pulse control

Up to 5th harmonic or
tunable extensions

Air-cooled and
water-cooled models

Compact industrial-grade design

CARBIDE-CB3
Typical pulse duration

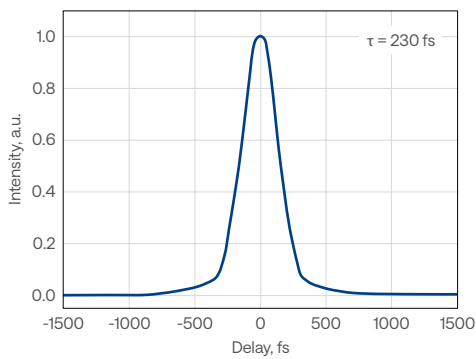

CARBIDE-CB3
Typical spectrum

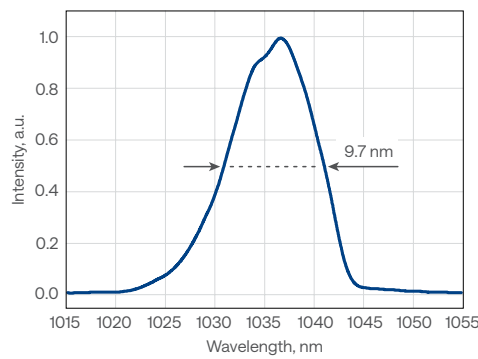

CARBIDE-CB3
Typical beam profile

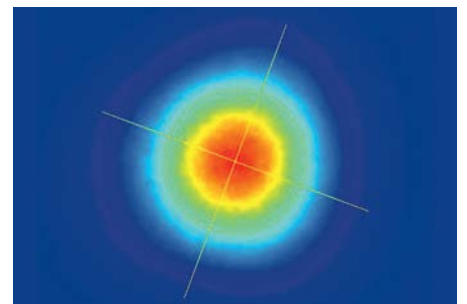

CARBIDE-CB3-120W
Long-term power stability

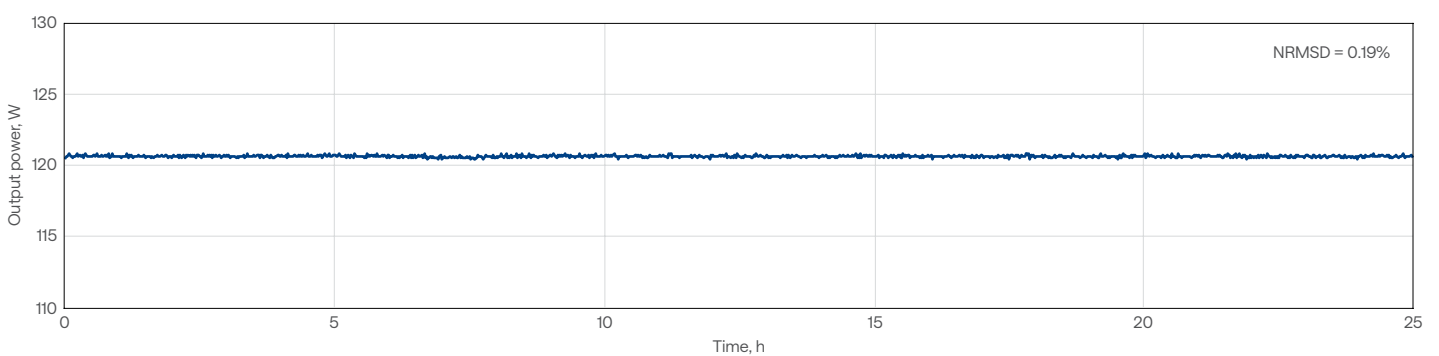

CARBIDE-CB3 specifications

NEW

Model	CB3-20W	CB3-40W	CB3-80W	CB3-120W
-------	---------	---------	---------	----------

OUTPUT CHARACTERISTICS

Cooling method	Water-cooled			
Center wavelength	1030 ± 10 nm			
Maximum output power	20 W	40 W	80 W	120 W
Pulse duration ¹⁾	< 250 fs		< 350 fs ²⁾	< 250 fs
Pulse duration tuning range	250 fs – 10 ps		350 fs – 10 ps	250 fs – 10 ps
Maximum pulse energy	0.4 mJ	0.2 mJ	0.8 mJ	2 mJ
Repetition rate	Single-shot – 1 MHz	Single-shot-1 MHz (2 MHz on request)	Single-shot – 10 MHz	Single-shot – 2 MHz
Pulse selection	Single-shot, pulse-on-demand, any fundamental repetition rate division			
Polarization	Linear, vertical; 1: 1000			
Beam quality, M ²	< 1.2			
Beam diameter ³⁾	3.9 ± 0.4 mm		4.2 ± 0.4 mm	5.1 ± 0.7 mm
Beam pointing stability	< 20 µrad/°C			
Pulse energy control	FEC ⁴⁾	Attenuator ⁵⁾	FEC ⁴⁾	
Pulse picker leakage	< 0.25%	< 0.5%	< 0.25%	
Pulse-to-pulse energy stability, 24 h ⁶⁾	< 0.5%			
Long-term power stability, 100 h ⁶⁾	< 0.5%			

MAIN OPTIONS

Oscillator output	< 0.5 W, 120 – 250 fs, 1030 ± 10 nm, ≈ 65 MHz ⁷⁾			
Harmonic generator ⁸⁾	515 nm, 343 nm, 257 nm, or 206 nm; see page 22			
Optical parametric amplifier ⁹⁾	320 – 10000 nm; see page 26			n/a
BiBurst option	Tunable GHz and MHz burst with burst-in-burst capability; see page 13			

PHYSICAL DIMENSIONS

Laser head (L × W × H)	633 × 350 × 174 mm		
Chiller (L × W × H)	585 × 484 × 221 mm	680 × 484 × 307 mm	
24 V DC power supply (L × W × H)	280 × 144 × 49 mm ¹⁰⁾	320 × 200 × 75 mm	376 × 449 × 88 mm

ENVIRONMENTAL AND UTILITY REQUIREMENTS

Operating temperature	15 – 30 °C		
Relative humidity	< 80% (non-condensing)		
Electrical requirements	Laser	100 V AC, 7 A – 240 V AC, 3A; 50 – 60 Hz	100 V AC, 12 A – 240 V AC, 5 A 50 – 60 Hz
	Chiller	100 – 230 V AC; 50 – 60 Hz	200 – 230 V AC; 50 – 60 Hz
Rated power	Laser	600 W	1000 W
	Chiller	1400 W	2000 W
Power consumption	Laser	500 W	900 W
	Chiller	1000 W	1300 W

¹⁾ Assuming Gaussian pulse shape.

²⁾ Pulse duration can be reduced to < 250 fs if pulse peak intensity of > 50 GW/cm² is tolerated by the customer setup.

³⁾ FW 1/e², using maximum pulse energy.

⁴⁾ Fast energy control (FEC) provides fast, full-scale individual pulse energy control; an external analog control input is available.

⁵⁾ Waveplate-based variable optical attenuator (VOA); an external analog control input is available.

⁶⁾ Under stable environmental conditions. Expressed as normalized root mean squared deviation (NRMSSD)

⁷⁾ Available simultaneously, requires a scientific interface. Contact sales@lightcon.com for more details or customized solutions.

⁸⁾ Integrated. For external harmonic generator, refer to HIRO.

⁹⁾ Integrated. For more options and OPAs, refer to www.lightcon.com.

¹⁰⁾ Power supply can be different if optional 2 MHz version is selected.

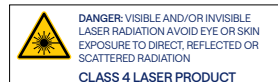

CARBIDE-CB5 (air-cooled) specifications

Model	CB5		CB5-SP
OUTPUT CHARACTERISTICS			
Cooling method	Air-cooled ¹⁾		
Center wavelength	1030 ± 10 nm		
Maximum output power	6 W	5 W	
Pulse duration ²⁾	< 290 fs		< 190 fs
Pulse duration tuning range	290 fs – 20 ps		190 fs – 20 ps
Maximum pulse energy	100 µJ	83 µJ	100 µJ
Repetition rate	Single-shot – 1 MHz		
Pulse selection	Single-shot, pulse-on-demand, any fundamental repetition rate division		
Polarization	Linear, vertical; 1: 1000		
Beam quality, M ²	< 1.2		
Beam diameter ³⁾	2.1 ± 0.4 mm		
Beam pointing stability	< 20 µrad/°C		
Pulse energy control	Attenuator ⁴⁾	AOM ⁵⁾	Attenuator ⁴⁾
Pulse picker leakage	< 2%	< 0.1%	< 2%
Pulse-to-pulse energy stability, 24 h ⁶⁾	< 0.5%		
Long-term power stability, 100 h ⁶⁾	< 0.5%		

MAIN OPTIONS

Oscillator output	n/a		
Harmonic generator ⁷⁾	515 nm, 343 nm, 257 nm, or 206 nm; see page 22		
Optical parametric amplifier ⁸⁾	320 – 10000 nm; see page 26		
BiBurst option	n/a		

PHYSICAL DIMENSIONS

Laser head (L × W × H)	633 × 324 × 162 mm		
Chiller	Not required		
24 V DC power supply (L × W × H)	220 × 95 × 46 mm		

ENVIRONMENTAL AND UTILITY REQUIREMENTS

Operating temperature	17 – 27 °C		
Relative humidity	< 80% (non-condensing)		
Electrical requirements	100 V AC, 3 A – 240 V AC, 1.3 A; 50 – 60 Hz		
Rated power	300 W		
Power consumption	150 W		

¹⁾ Water-cooled version available on request.

²⁾ Assuming Gaussian pulse shape.

³⁾ $FW\ 1/e^2$, using maximum pulse energy.

⁴⁾ Waveplate-based variable optical attenuator (VOA); an external analog control input is available.

⁵⁾ Enhanced contrast AOM. Provides fast amplitude control of output pulse train.

⁶⁾ Under stable environmental conditions. Expressed as normalized root mean squared deviation (NRMSD).

⁷⁾ Integrated. For external harmonic generator, refer to HIRO.

⁸⁾ Integrated. For stand-alone OPAs, refer to www.lightcon.com.

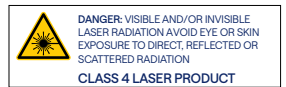

CARBIDE-CB5-SP
Typical pulse duration

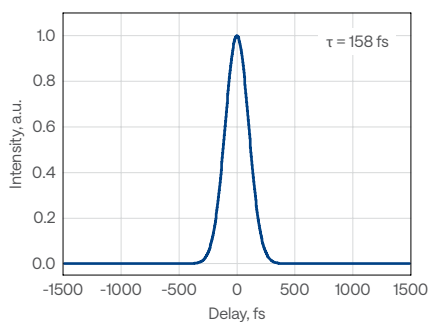

CARBIDE-CB5
Long-term power stability

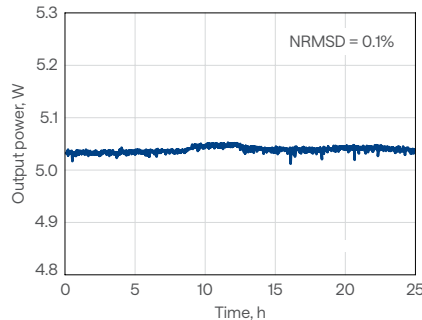

CARBIDE-CB5
Typical beam profile

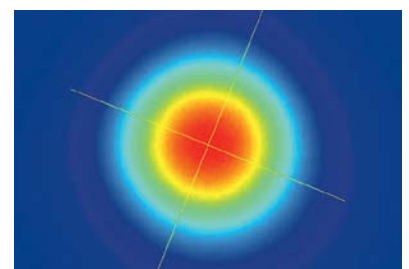

Stability measurements

CARBIDE-CB3 output power and beam direction stability with power lock enabled, across varying environmental conditions

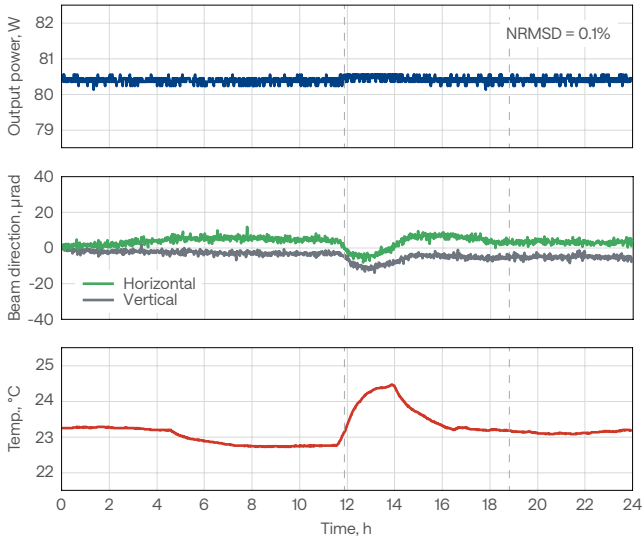

CARBIDE-CB3
Typical pulse-to-pulse energy stability

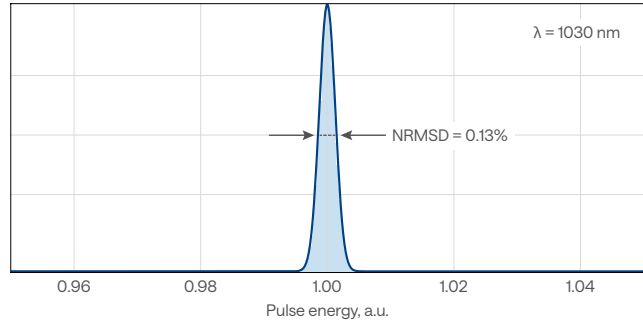

Drawings

CARBIDE-CB3 drawing

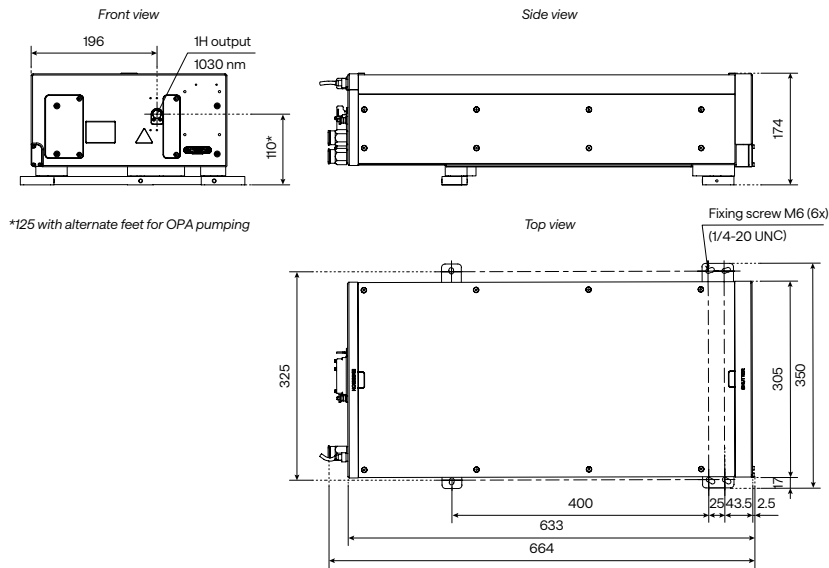

Air-cooled CARBIDE-CB5 with attenuator drawing

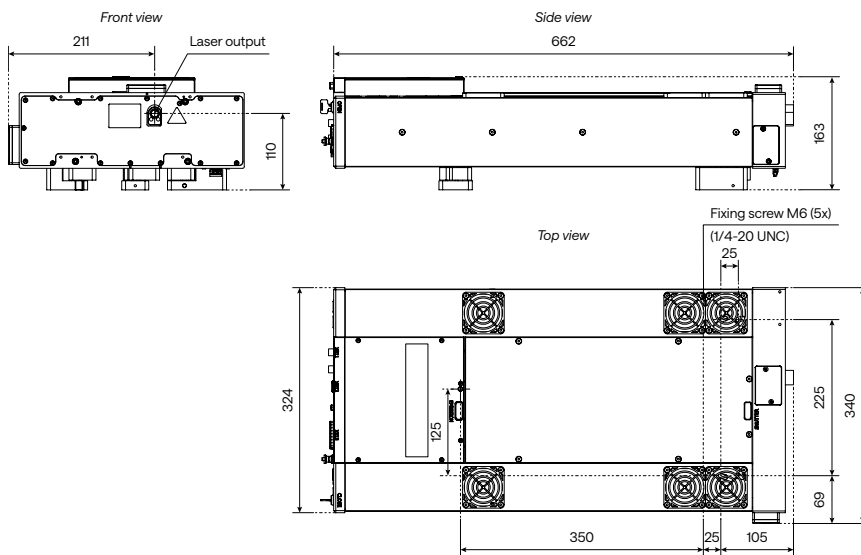

CARBIDE | CB3-UV

High-Power UV Femtosecond Lasers



CARBIDE-CB3-UV

Maximum output of 50 W

500 fs pulse duration

Up to MHz repetition rate

High beam quality and stability

Compact industrial-grade design

CARBIDE-CB3-UV
Typical spectrum

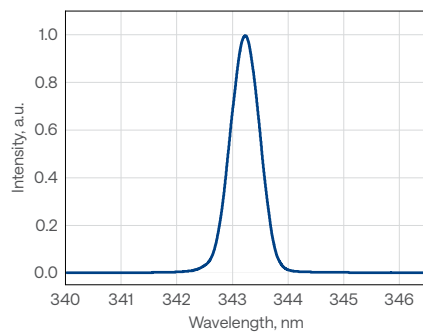

CARBIDE-CB3-UV
Typical M² measurement data

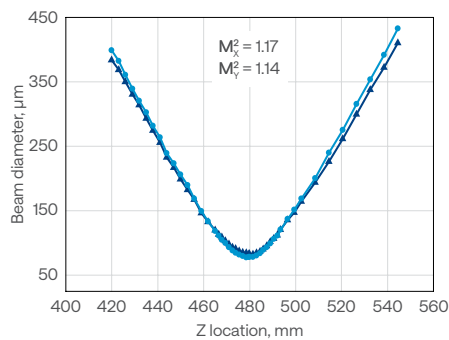

CARBIDE-CB3-UV
Beam profile

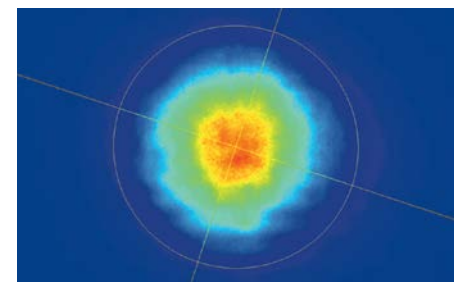

CARBIDE-CB3-UV-50W
Long-term power stability

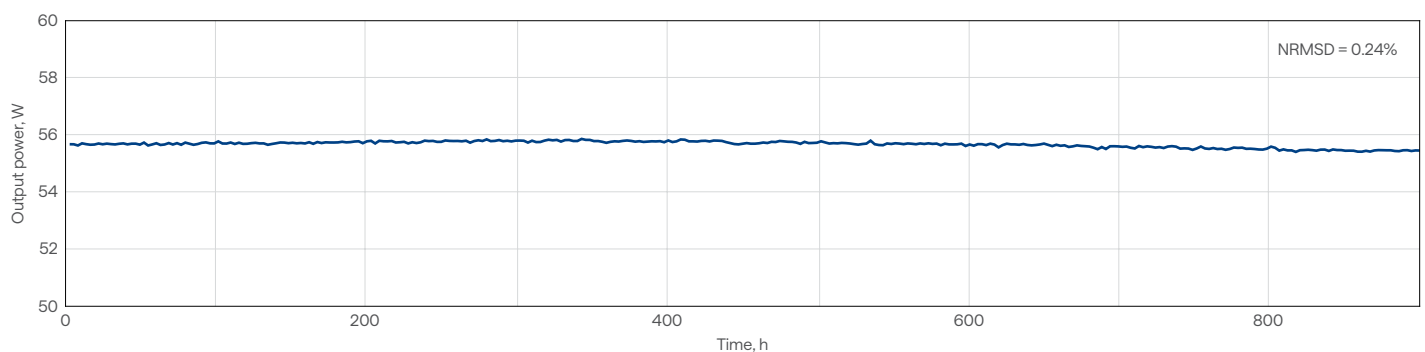

Specifications

Model	CB3-UV-30W	CB3-UV-50W
-------	------------	------------

OUTPUT CHARACTERISTICS

Cooling method	Water-cooled	
Center wavelength	343 ± 3 nm	
Output power	> 30 W	> 50 W
Pulse duration ¹⁾	≈ 500 fs	
Output pulse energy	35 – 150 μJ	
Repetition rate ²⁾	200 – 800 kHz	300 – 1000 kHz
Polarization	Linear, vertical; 1 : 200	
Beam quality, M ² , typical values	< 1.3	
Beam diameter ³⁾	2 - 5 mm	
Long-term power stability, 12 h ⁴⁾	< 0.5%	
Lifetime	10000 h	

MAIN OPTIONS

Optional amplifier outputs	1030 nm, 515 nm
----------------------------	-----------------

PHYSICAL DIMENSIONS

Laser head (L × W × H)	801 × 350 × 174 mm
Chiller (L × W × H)	680 × 484 × 307 mm
24 V DC power supply (L × W × H)	320 × 200 × 75 mm 376 × 449 × 88 mm

ENVIRONMENTAL AND UTILITY REQUIREMENTS

Operating temperature	15 – 30 °C	
Relative humidity	< 80% (non-condensing)	
Electrical requirements	Laser	100 V AC, 12 A – 240 V AC, 5 A; 50 – 60 Hz 100 V AC, 15 A - 240 V AC, 7 A; 50 - 60 Hz
	Chiller	200 – 230 V AC; 50 – 60 Hz
Rated power	Laser	1000 W 2000 W
	Chiller	2000 W
Power consumption	Laser	900 W 1500 W
	Chiller	1300 W 1800 W

¹⁾ Assuming Gaussian pulse shape.

²⁾ Repetition rate available up to 2 MHz at lower power.

³⁾ FW 1/e², using maximum pulse energy.

⁴⁾ Under stable environmental conditions. Expressed as normalized root mean squared deviation (NRMSD).

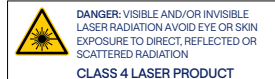

Drawings

CARBIDE-CB3-UV drawing

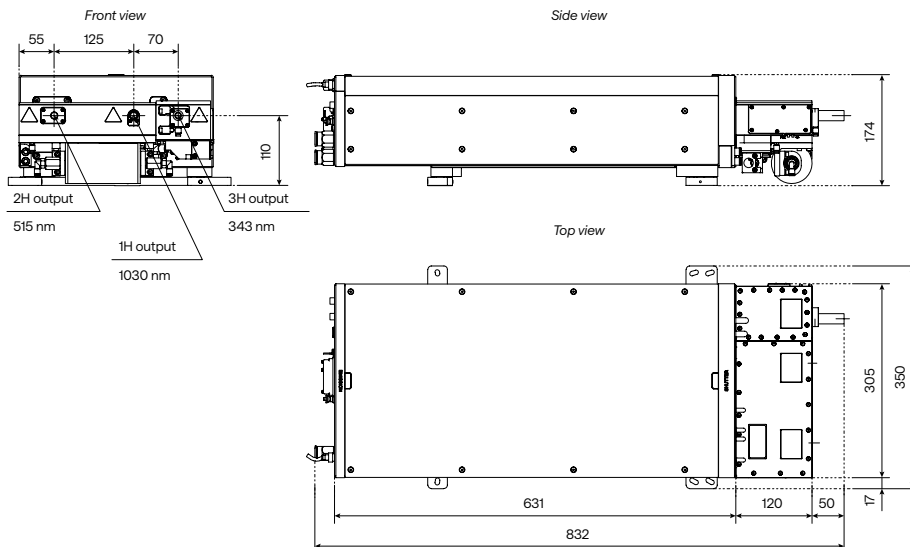

SCI-M | CARBIDE

Scientific Interface Module for CARBIDE



Simultaneous or separate oscillator output

Uncompressed laser output

Seeding by an external oscillator

Beam-splitting options

Drawings

CARBIDE-CB3-40W with a scientific interface module drawing

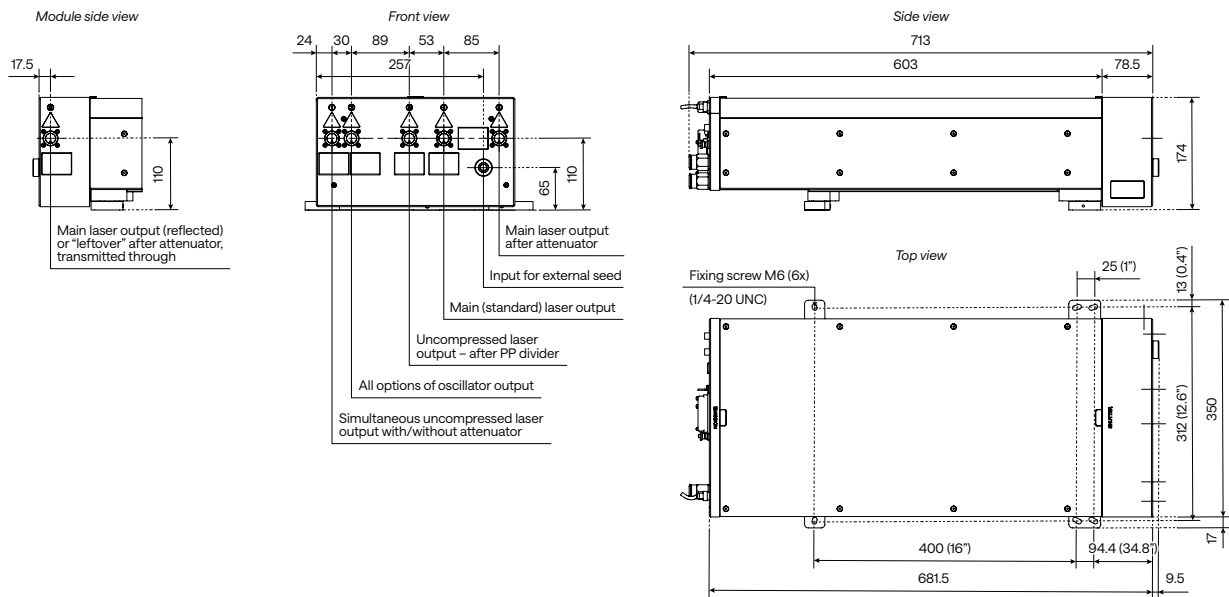

BiBurst | OPTION

Tunable GHz and MHz Burst with Burst-in-Burst Capability

PHAROS and CARBIDE-CB3 lasers offer an option for tunable GHz and MHz burst with burst-in-burst capability, known as BiBurst.

In standard mode, a single pulse is emitted at a fixed frequency. In burst mode, the output consists of pulse packets rather than single pulses. Each packet comprises a certain number of equally spaced pulses. MHz-Burst contains N pulses with a nanosecond period, while GHz-Burst contains P pulses with a picosecond period. When both GHz and MHz burst modes are used simultaneously, the equally spaced pulse packets contain sub-packets of pulses, known as burst-in-burst or BiBurst.

PHAROS and CARBIDE lasers with the BiBurst option bring new capabilities to high-tech manufacturing industries such as consumer electronics, integrated photonic chip manufacturing, future display manufacturing, and quantum technologies. The applications include:

- brittle material drilling and cutting
- deep engraving
- selective ablation
- volume modification of transparent materials
- hidden marking
- surface polishing
- functional surface structuring

Specifications

Model		CARBIDE-CB3	PHAROS
GHz Burst	Intra burst pulse period ¹⁾	440 ± 40 ps	200 ± 40 ps
	Number of pulses, P ²⁾	1 – 10 ³⁾	1 – 25
MHz Burst	Intra burst pulse period	≈ 15 ns	
	Number of pulses, N	1 – 10	1 – 9 (7 with FEC ⁴⁾)

¹⁾ Custom spacing is available upon request.

²⁾ The maximum number of pulses in a burst depends on the laser repetition rate and energy.

³⁾ A custom number of pulses (up to 400) is available upon request.

⁴⁾ Fast energy control option. Enables the formation of any pulse envelope at the laser pulse repetition rate.

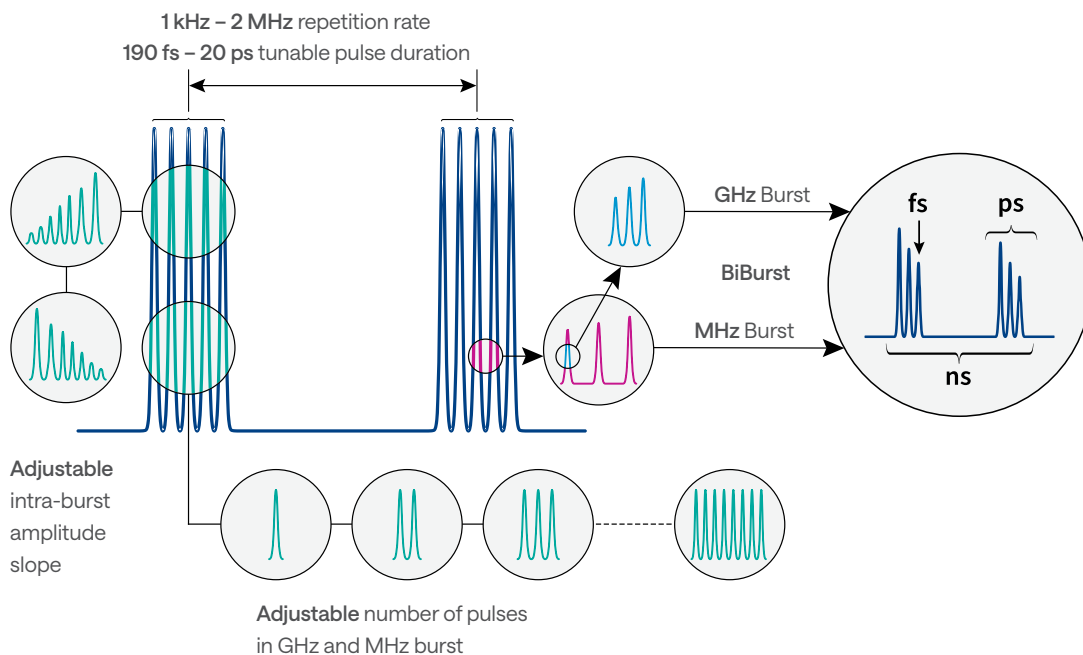

PHAROS

Modular-Design Femtosecond Lasers for Industry and Science



Tunable pulse duration, 100 fs – 20 ps

Maximum pulse energy of up to 4 mJ

Down to < 100 fs right at the output

Pulse-on-demand and BiBurst for pulse control

Up to 5th harmonic or tunable extensions

CEP stabilization or repetition rate locking

Thermally-stabilized and sealed design

PHAROS-PH2-UP
Typical pulse duration

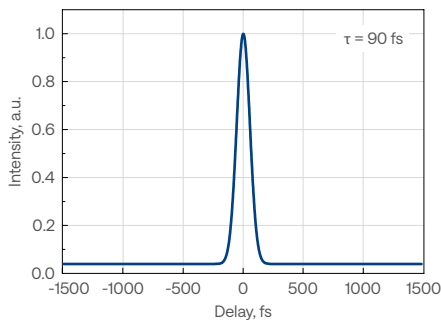

PHAROS-PH2-UP
Typical spectrum

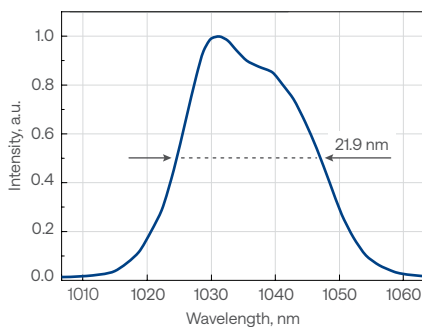

PHAROS
Pulse energy vs fundamental repetition rate

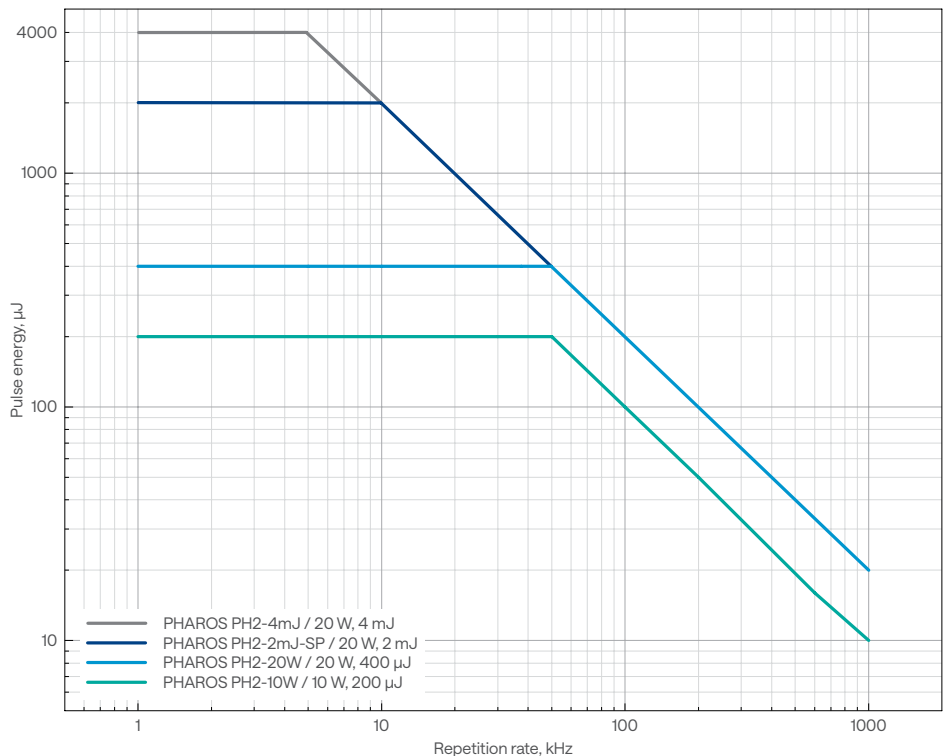

Specifications

Model	PH2-10W	PH2-20W-SP		PH2-4mJ	PH2-UP
-------	---------	------------	--	---------	--------

OUTPUT CHARACTERISTICS

Center wavelength ¹⁾	1030 ± 10 nm				
Maximum output power	10 W	20 W			
Pulse duration ²⁾	< 290 fs	< 190 fs		< 450 fs ³⁾	< 100 fs
Pulse duration tuning range	290 fs – 10 ps (20 ps on request)	190 fs – 10 ps (20 ps on request)		450 fs – 10 ps	100 fs – 10 ps
Maximum pulse energy	0.2 mJ	0.4 mJ	1 mJ	2 mJ	4 mJ
Repetition rate	Single-shot – 1 MHz				
Pulse selection	Single-shot, pulse-on-demand, any fundamental repetition rate division				
Polarization	Linear, horizontal				
Beam quality, M ²	< 1.2	< 1.3			< 1.2
Beam diameter ⁴⁾	3.3 ± 0.5 mm	4.0 ± 0.5 mm	4.5 ± 0.5 mm	6.8 ± 0.7 mm	4.5 ± 0.5 mm
Beam pointing stability	< 20 µrad/°C				
Pre-pulse contrast	< 1: 1000				
Post-pulse contrast	< 1: 200				
Pulse-to-pulse energy stability, 24 h ⁵⁾	< 0.5%				
Long-term power stability, 100 h ⁵⁾	< 0.5%				

MAIN OPTIONS

Oscillator output ⁶⁾	1 – 7 W, 50 – 250 fs, ≈ 1035 nm, ≈ 76 MHz				
Harmonic generator ⁷⁾	515 nm, 343 nm, 257 nm, or 206 nm; see page 23				
Optical parametric amplifier ⁸⁾	320 – 10000 nm; see page 26				
BiBurst option	Tunable GHz and MHz burst with burst-in-burst capability; see page 13				
CEP stabilization	See page 17				
Repetition rate locking					

PHYSICAL DIMENSIONS

Laser head (L × W × H) ⁹⁾	730 × 419 × 230 mm	827 × 492 × 250 mm	730 × 419 × 230 mm
Chiller (L × W × H)	590 × 484 × 267 mm		
24 V DC power supply (L × W × H) ⁹⁾	280 × 144 × 49 mm		

ENVIRONMENTAL & UTILITY REQUIREMENTS

Operating temperature	15 – 30 °C (air conditioning recommended)	
Relative humidity	< 80% (non-condensing)	
Electrical requirements	Laser	100 V AC, 12 A – 240 V AC, 5 A, 50 – 60 Hz
	Chiller	100 – 230 V AC, 50 – 60 Hz
Rated power	Laser	1000 W
	Chiller	1400 W
Power consumption	Laser	600 W
	Chiller	1000 W

¹⁾ Precise wavelengths for specific models are available upon request.

²⁾ Assuming Gaussian pulse shape.

³⁾ Pulse duration can be reduced to < 250 fs if pulse peak intensity of > 50 GW/cm² is tolerated by the customer setup.

⁴⁾ FW 1/e², measured at laser output, using maximum pulse energy.

⁵⁾ Under stable environmental conditions. Expressed as normalized root mean squared deviation (NRMSD).

⁶⁾ Available simultaneously. Contact sales@lightcon.com for more details or customized solutions.

⁷⁾ Integrated. For external harmonic generator, refer to HIRO.

⁸⁾ Integrated. For more options and OPAs for -4mJ and -UP models, refer to www.lightcon.com.

⁹⁾ Dimensions depend on laser configuration and integrated options.

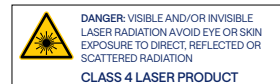

Beam properties

PHAROS

Typical M^2 measurement data

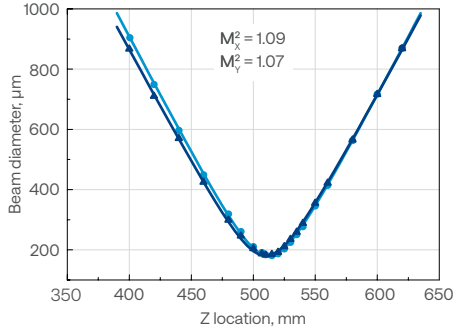

PHAROS

Typical near-field beam profile

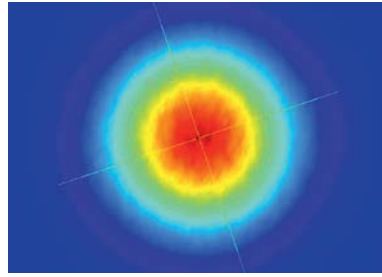

PHAROS

Typical far-field beam profile

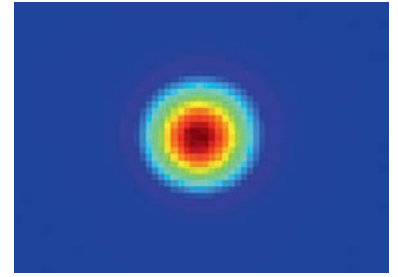

Stability measurements

PHAROS

Long-term power stability

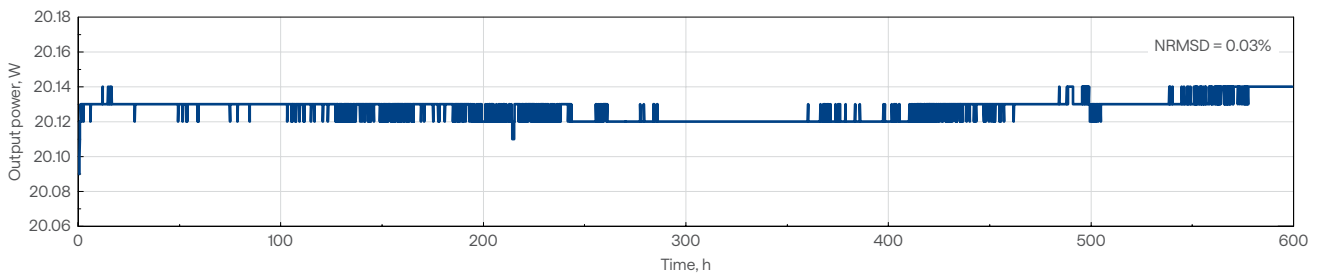

Output power of industrial-grade PHAROS lasers operating 24/7 and the current of the pump diodes over the years

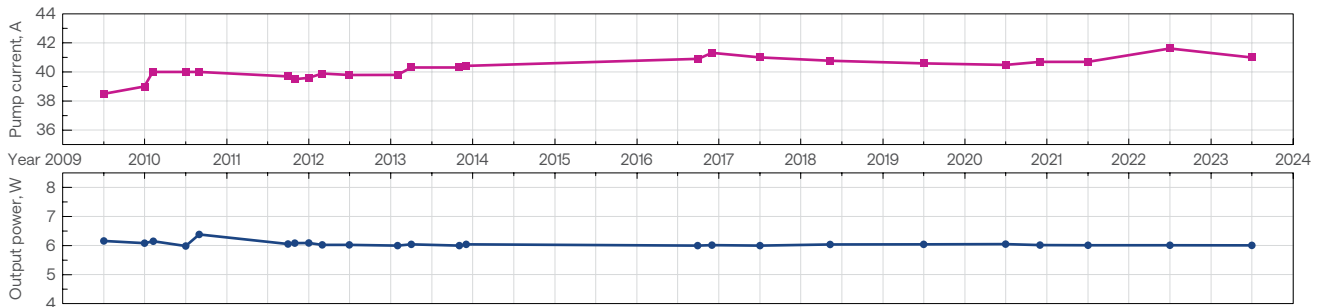

PHAROS output power and the stability of beam direction with power lock enabled, across varying environmental conditions

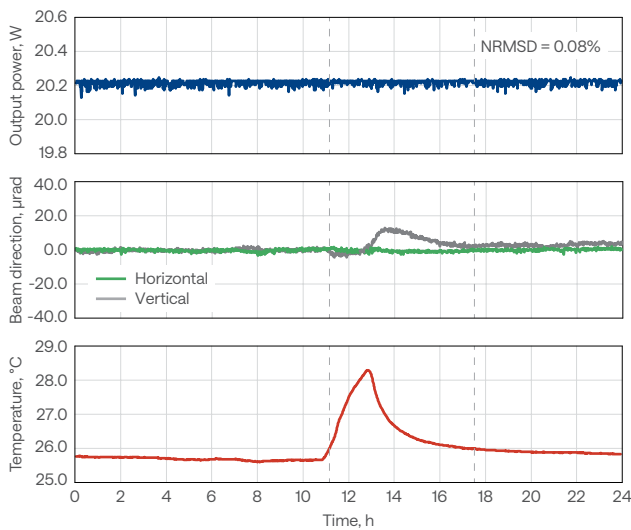

PHAROS

Typical pulse-to-pulse energy stability

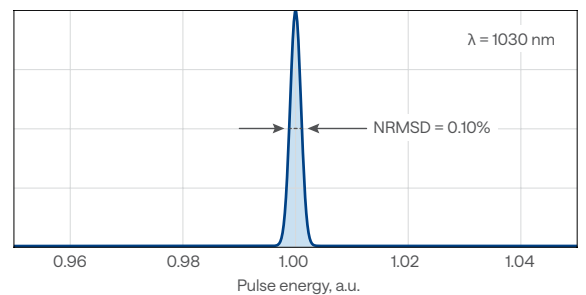

CEP stabilization

PHAROS lasers can be equipped with feedback electronics for carrier-envelope phase (CEP) stabilization of the output pulses. The carrier-envelope offset (CEO) of the PHAROS oscillator is actively locked to $1/4^{\text{th}}$ of the repetition rate with a < 100 mrad standard deviation. The CEP stable pulses from the

synchronized amplifier have a < 350 mrad standard deviation. The CEP drift occurring inside the amplifier and the user's setup can be compensated with an out of loop $f-2f$ interferometer, which is a part of the complete PHAROS active CEP stabilization package.

PHAROS

Short-term CEP stability operating at 200 kHz repetition rate

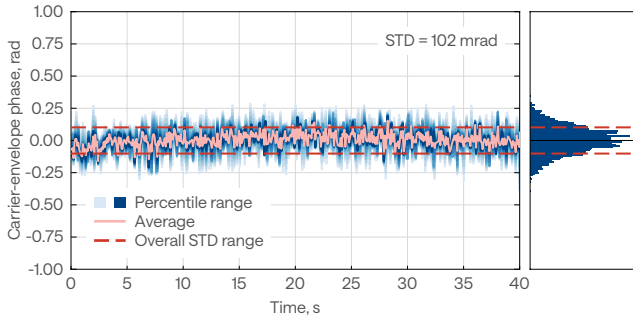

PHAROS

Long-term CEP stability operating at 200 kHz repetition rate

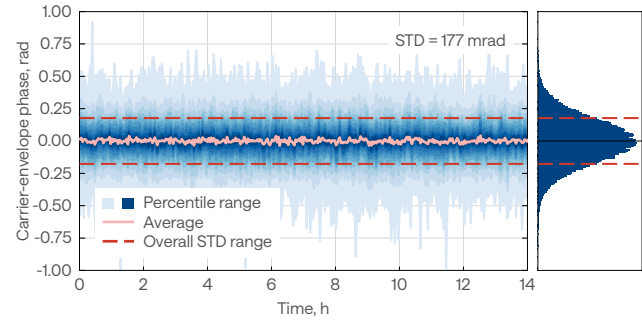

Repetition rate locking

The oscillator of PHAROS laser can be customized for repetition rate locking applications. Coupled with the necessary feedback electronics, the repetition rate is synchronized to an external RF source using the two piezo stages installed inside the cavity.

The repetition rate locking system can assure an integrated timing jitter of less than 200 fs for RF reference frequencies larger than 500 MHz. Continuous phase shifting is available on request.

Phase noise data of PHAROS oscillator locked to a 2.8 GHz RF source

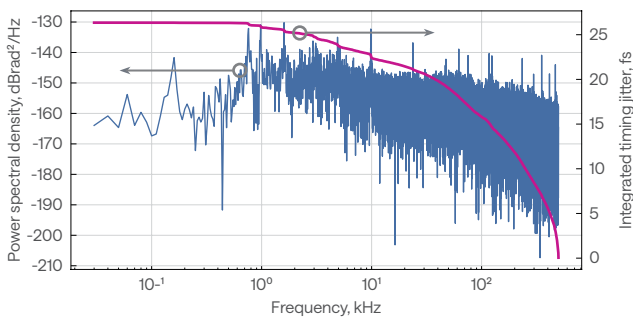

Timing jitter stability over 14 h

PHAROS oscillator locked to a 2.8 GHz RF source

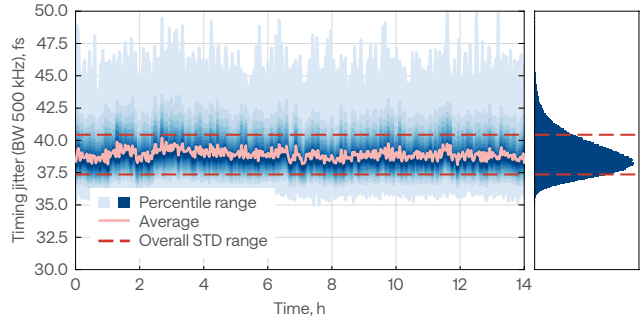

Drawings

PHAROS-PH2-730 drawing.

PH2 or PH2-SP with FEC, BiBurst, or harmonics; also, PH2-UP without harmonics

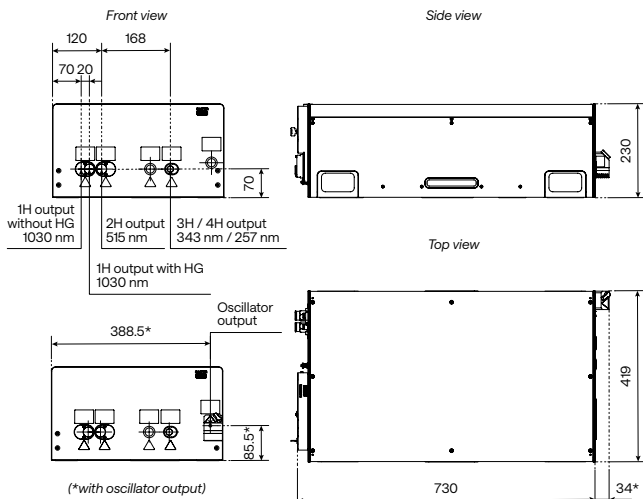

PHAROS-PH2-827 drawing

PH2 with -HE harmonics, PH2-4mJ, or PH2-UP with harmonics

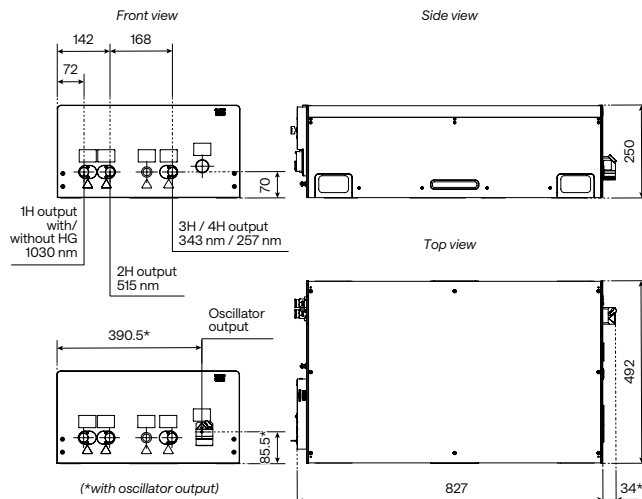

High-Repetition-Rate Lasers



FLINT-FL1

From 10 to 100 MHz repetition rate

Down to 50 fs pulse duration

High-power models, up to 20 W

High-energy energy models, up to 0.5 μ J

Industrial-grade design for high output stability

CEP stabilization or repetition rate locking

FLINT-FL1
Typical spectrum

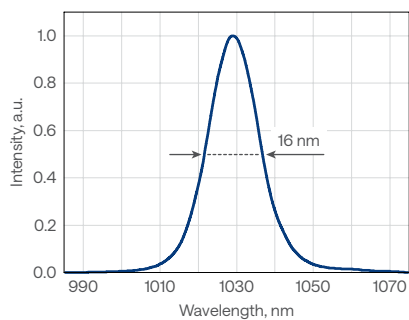

FLINT-FL1
Typical pulse duration

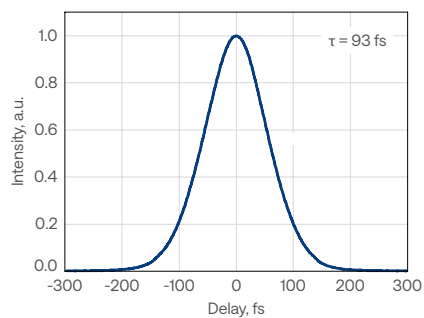

FLINT-FL1
Typical beam profile

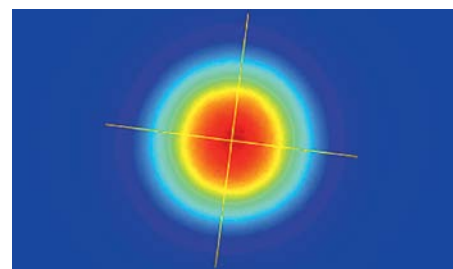

FLINT-FL2-SP
Typical spectrum

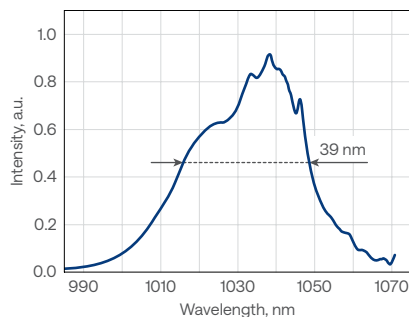

FLINT-FL2-SP
Typical pulse duration

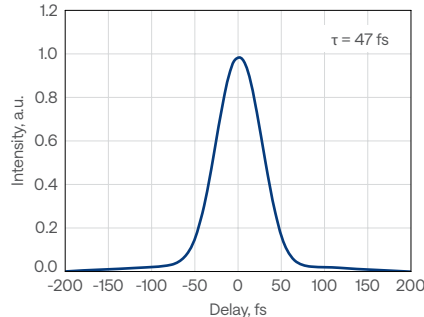

FLINT-FL2-SP
Typical beam profile

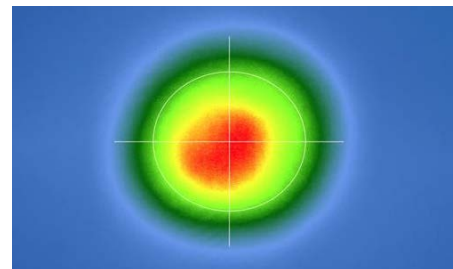

Specifications

Model	FL1			FL2-SP	FL2		
Key feature	CEP	RRL	Compact	Short pulse	High power and high energy		
Pulse duration	< 100 fs		< 120 fs	< 50 fs	< 120 fs	< 170 fs ¹⁾	
Repetition rate	60 – 100 MHz ²⁾			10 MHz	10 MHz	40 MHz	80 MHz
Maximum output power	0.5 W	1 W	8 W	4 W	5 W	20 W	
Maximum pulse energy	6 nJ ³⁾	12.5 nJ ³⁾	100 nJ ³⁾	0.4 μJ	0.5 μJ		0.25 μJ
Center wavelength	1035 ± 10 nm			1030 ± 10 nm	1030 ± 10 nm		
Polarization	Linear, horizontal						
Beam quality, M ²	< 1.2			< 1.3	< 1.2		
Beam pointing stability	< 10 μrad/°C						
Long-term power stability, 100 h ⁴⁾	< 0.5%						
Integrated 2H generator ⁵⁾	n/a				Optional; conversion efficiency > 30% ⁶⁾ ; see page 21		
External 2H, 3H, or 4H generator ⁵⁾	Optional; see page 24						
Integrated attenuator	n/a			Included			

PHYSICAL DIMENSIONS

Laser head (L × W × H)	448 × 206 × 115 mm	543 × 322 × 146 mm
Power supply and chiller rack (L × W × H)	642 × 553 × 540 mm	642 × 553 × 673 mm
Chiller	Different options available. Contact sales@lightcon.com	

ENVIRONMENTAL AND UTILITY REQUIREMENTS

Operating temperature	15 – 30 °C (air conditioning recommended)	
Relative humidity	< 80% (non-condensing)	
Electrical requirements	100 V AC, 7 A – 240 V AC, 3 A; 50 – 60 Hz	100 V AC, 12 A – 240 V AC, 5 A; 50 – 60 Hz
Rated power	200 W	
Power consumption	Laser	100 W
	Chiller	600 W
		150 W
		1000 W

¹⁾ For 20 W output power. Lower power models: 8 W and 12 W, are available upon request.

²⁾ Standard repetition rate is 80 MHz; custom repetition rate can be factory preset from the given range.

³⁾ Depends on the repetition rate. Values are given for 80 MHz.

⁴⁾ With enabled power-lock, under stable environmental conditions. Expressed as normalized root mean squared deviation (NRMSD).

⁵⁾ For external 2H, or even 3H and 4H generation, refer to HIRO for FLINT.

⁶⁾ Conversion efficiency specified at maximum power.

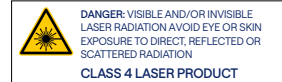

Stability

FLINT-FL2 (20 W) output power stability under harsh environmental conditions over 7 days

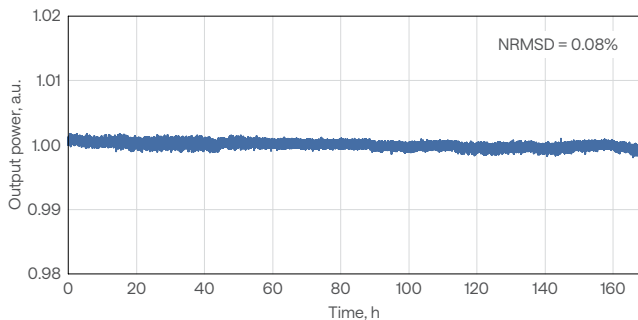

FLINT oscillator relative intensity noise (RIN), shot-noise limited at -160 dBc/Hz above 1 MHz

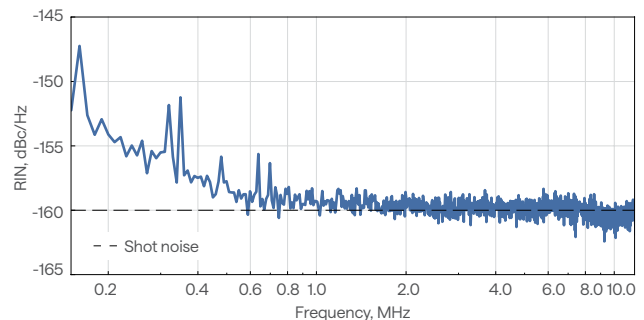

CEP stabilization

FLINT oscillators can be equipped with feedback electronics for carrier-envelope phase (CEP) stabilization of the output pulses. The carrier-envelope offset (CEO) of the oscillator is actively locked to 1/4th of the repetition rate with a < 100 mrad standard deviation.

CEP-locked FLINT oscillator phase noise data

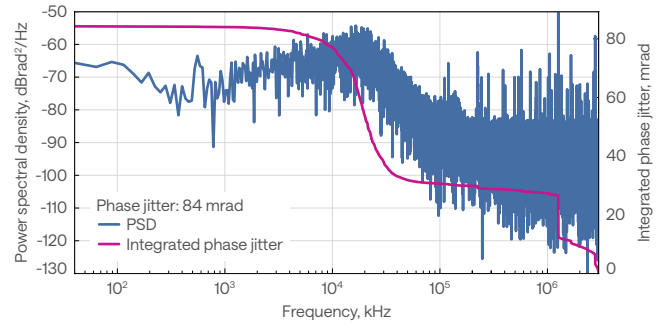

Repetition rate locking

FLINT oscillators are customizable for repetition rate locking applications. Coupled with the necessary feedback electronics, the repetition rate can be synchronized to an external RF source using the two piezo stages installed inside the cavity.

The repetition rate locking system can assure an integrated timing jitter of less than 200 fs for RF reference frequencies larger than 500 MHz. Continuous phase shifting is available upon request.

FLINT oscillator phase noise data locked to a 2.8 GHz RF source

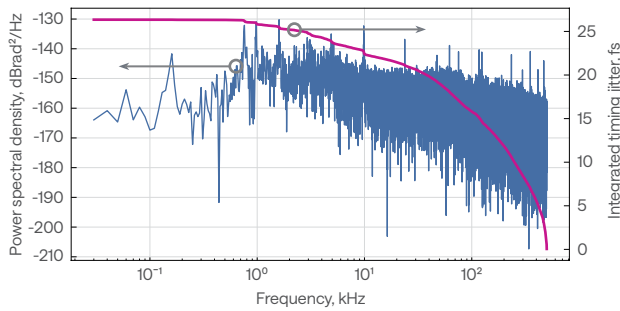

Timing jitter stability over 14 h: FLINT oscillator locked to a 2.8 GHz RF source

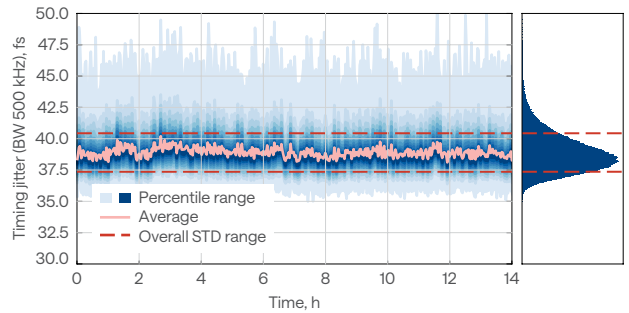

Drawings

FLINT-FL1 drawing

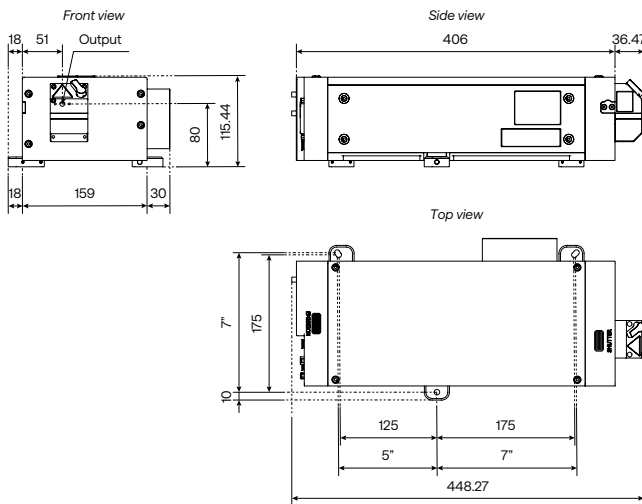

FLINT-FL2 drawing

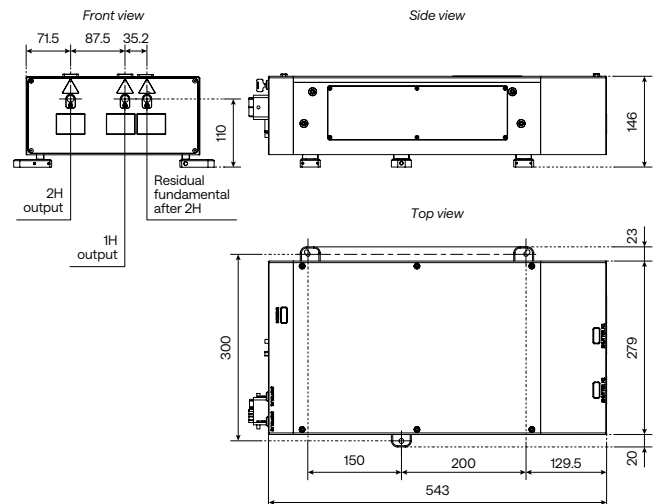

Second Harmonic Generator



FLINT-FL2 with integrated HG

515 nm output

Automated harmonic selection

Integrated into the housing

Industrial-grade design

Specifications

Model	FL1	FL2-SP	FL2		
Available harmonic	Refer to HIRO; see page 24		2H		
Pump repetition rate			10 MHz	40 MHz	80 MHz
Maximum pump power			5 W	20 W	
Center wavelength			515 ± 10 nm		
Conversion efficiency ¹⁾			> 30%		
Polarization			Linear, horizontal		

¹⁾ Conversion efficiency specified at maximum power.

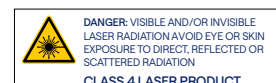

Automated Harmonic Generators



CARBIDE-CB3 with 2H-3H

- 515 nm, 343 nm, 257 nm, or 206 nm output
- Automated harmonic selection
- Mounted directly on the laser head
- Industrial-grade design
- 50 W UV model

Specifications

Model	2H	2H-3H	2H-4H	2H-5H	30W UV ¹⁾	50W UV ¹⁾
Output wavelength ²⁾ (automated selection)	1030 nm 515 nm	1030 nm 515 nm 343 nm	1030 nm 515 nm 257 nm	1030 nm 515 nm 206 nm	1030 nm 515 nm 343 nm	1030 nm 515 nm 343 nm
Pump pulse energy	20 – 2000 μ J	50 – 2000 μ J	20 – 2000 μ J	100 -1500 μ J	80 – 400 μ J	120 – 400 μ J
Pump pulse duration	< 300 fs				\approx 500 fs	
Conversion efficiency / Output power	> 50% (2H)	> 50% (2H) > 25% (3H)	> 50% (2H) > 10% (4H) ³⁾	> 50% (2H) > 5% (5H) ⁴⁾	30 W (3H)	50 W (3H)
Beam quality, M^2 , typical values	\leq 400 μ J pump	< 1.15 (2H) < 1.2 (3H)	< 1.15 (2H) n/a (4H)	n/a	< 1.3 (3H)	< 1.3 (3H)
	> 400 μ J pump	< 1.2 (2H) < 1.3 (3H)	< 1.2 (2H) n/a (4H)	n/a		

¹⁾ Refer to CARBIDE-CB3-UV for more details.

²⁾ Depends on pump laser model. Up to 5th harmonic available; contact sales@lightcon.com for more details.

³⁾ Maximum output power of 5 W. More than 4 W is available at 50 – 400 μ J pump energies and \approx 500 fs pump pulse duration.

⁴⁾ Maximum output power of 0.2 W.

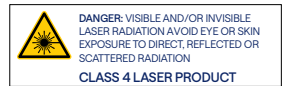

CARBIDE-CB5 (100 kHz, 6 W)
Typical 1H beam profile

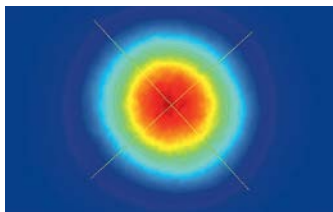

CARBIDE-CB5 (100 kHz, 3.4 W)
Typical 2H beam profile

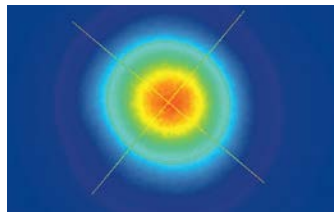

CARBIDE-CB5 (100 kHz, 2.2 W)
Typical 3H beam profile

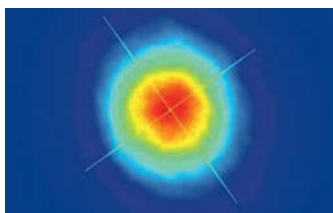

CARBIDE-CB5 (100 kHz, 100 mW)
Typical 4H beam profile

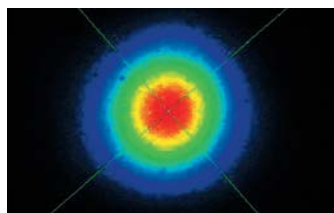

CARBIDE-CB3-80W with HG
Pulse energy vs repetition rate

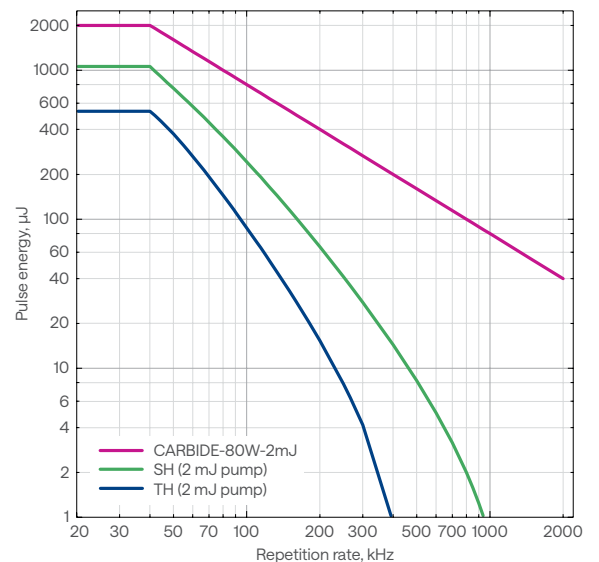

Automated Harmonic Generators

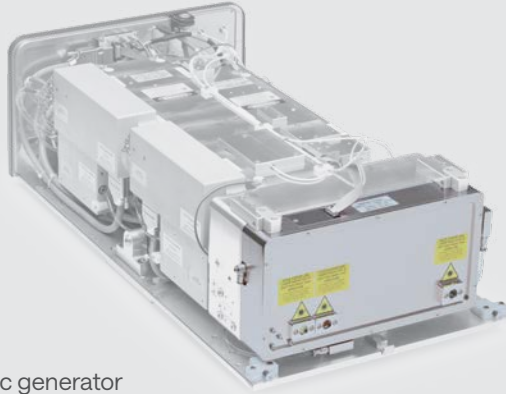

PHAROS with a harmonic generator

515 nm, 343 nm, 257 nm,
or 206 nm output

Automated harmonic selection

Industrial-grade design

Specifications

Model	2H (-HE)	2H-3H (-HE)	2H-4H (-HE)	4H-5H
Output wavelength ¹⁾ (automated selection)	1030 nm 515 nm	1030 nm 515 nm 343 nm	1030 nm 515 nm 257 nm	1030 nm 257 nm 206 nm
Pump pulse energy	20 – 4000 μ J	50 – 4000 μ J	20 – 4000 μ J	200 – 1000 μ J
Pump pulse duration	100 – 500 fs			
Conversion efficiency	> 50% (2H)	> 50% (2H) > 25% (3H)	> 50% (2H) > 10% (4H) ²⁾	> 10% (4H) ²⁾ > 5% (5H) ³⁾
Beam quality, M^2 , typical values	$\leq 400 \mu$ J pump	< 1.15 (2H)	< 1.15 (2H) < 1.2 (3H)	n/a
	> 400 μ J pump	< 1.2 (2H)	< 1.2 (2H) < 1.3 (3H)	

¹⁾ Depends on pump laser model.

²⁾ Maximum output power of 2 W at 20 – 1000 μ J pump
or 1 W at 1000 – 4000 μ J pump.

³⁾ Maximum output power of 150 mW.

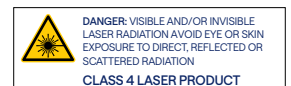

PHAROS with HG pulse energy vs repetition rate

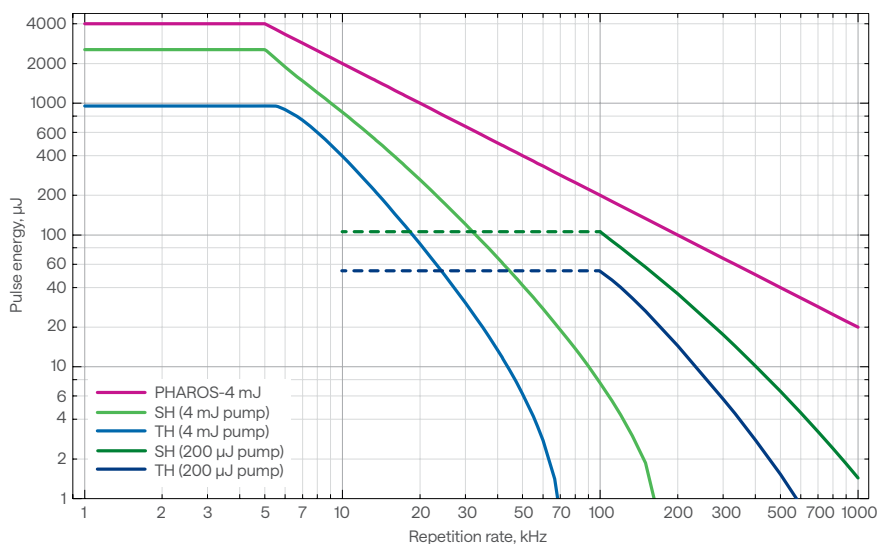

3H output power stability

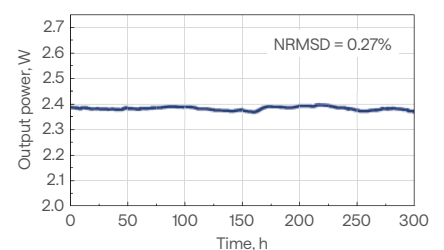

4H output power stability

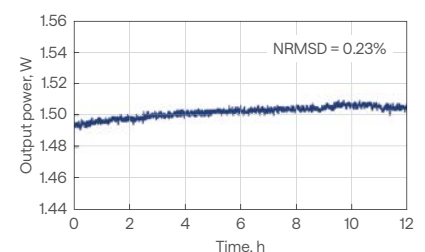

External Harmonic Generator



515 nm, 343 nm, 257 nm,
and 206 nm outputs

Simple selection of the
active harmonic

Simultaneous or
switchable outputs

Standalone harmonics for
PHAROS / CARBIDE and FLINT

HIRO for PHAROS / CARBIDE

Model	HIRO	HIRO-HP	HIRO-HE
Maximum pump power	20 W	80 W	
Pump pulse energy	8 – 400 μ J	200 – 1000 μ J	1000 – 4000 μ J
Available outputs ^{1 2)}	Up to 4H ³⁾	Up to 5H	
Conversion efficiency ^{1 4)}		> 50% (2H) > 25% (3H) > 10% (4H) ⁵⁾ > 5% (5H) ⁶⁾	
Polarization ⁷⁾		Linear, horizontal (2H, 5H) Linear, vertical (3H, 4H)	

PHYSICAL DIMENSIONS

Dimensions (L x W x H)	487 x 176 x 180 mm	552 x 320 x 170 mm
------------------------	--------------------	--------------------

¹⁾ For harmonic combinations and simultaneous outputs, contact sales@lightcon.com.

²⁾ Residual fundamental output available upon request.

³⁾ White light continuum output available upon request.

⁴⁾ Percentage of pump power, for repetition rate of up to 200 kHz.

⁵⁾ Maximum output power of 1 W.

⁶⁾ Maximum output power of 150 mW. Only for HIRO-HP/HE.

⁷⁾ Different polarization is available upon request.

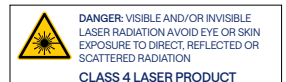

HIRO for FLINT

Model	HIRO
Available harmonic ¹⁾	Up to 4H
Maximum pump power	4 W
Conversion efficiency ²⁾	> 35% (2H) > 5% (3H) > 1% (4H)

PHYSICAL DIMENSIONS

Dimensions (L × W × H)	487 × 176 × 180 mm
------------------------	--------------------

¹⁾ For high power 2H, refer to HG for FLINT.

²⁾ For pump power of > 500 mW.

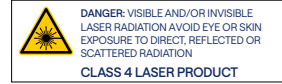

HIRO outputs

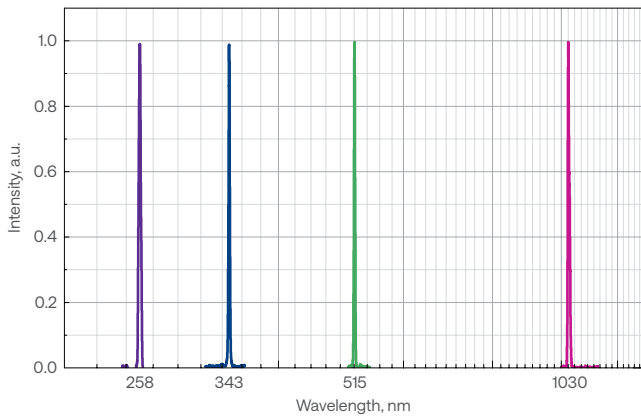

4H output power stability

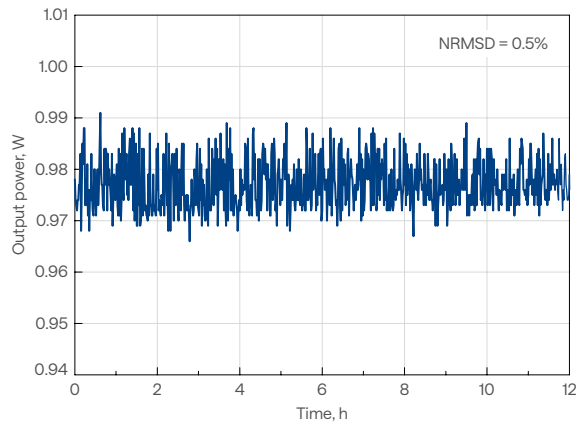

Drawings

HIRO drawing

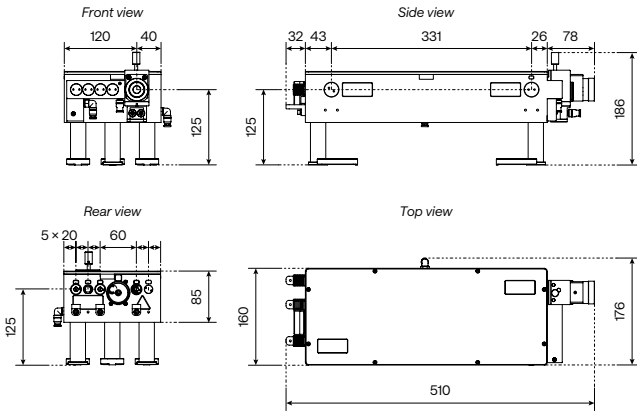

HIRO-HP/HE drawing

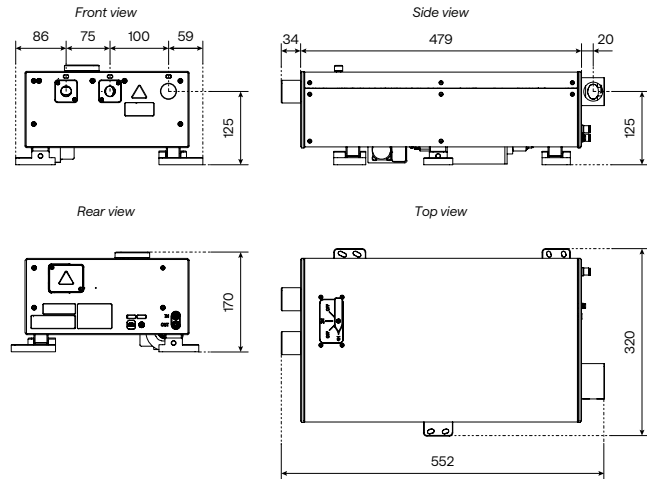

I-OPA

Industrial-Grade Optical Parametric Amplifier



I-OPA-TW on air-cooled CARBIDE-CB5

Wavelength tunability
in an industrial design

Single-box solution

Tunable or fixed-wavelength
models

Plug-and-play installation and
robust performance

The most compact OPA
in the market

I-OPA-HP typical tuning curves
Pump: 40 W, 400 μ J, 100 kHz

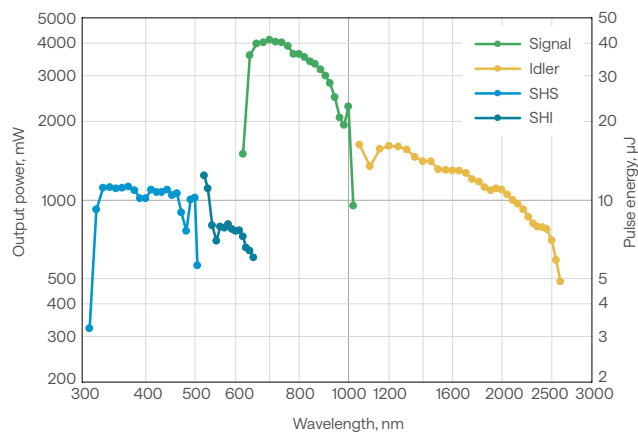

I-OPA-F typical tuning curves
Pump: 40 W, 400 μ J, 100 kHz

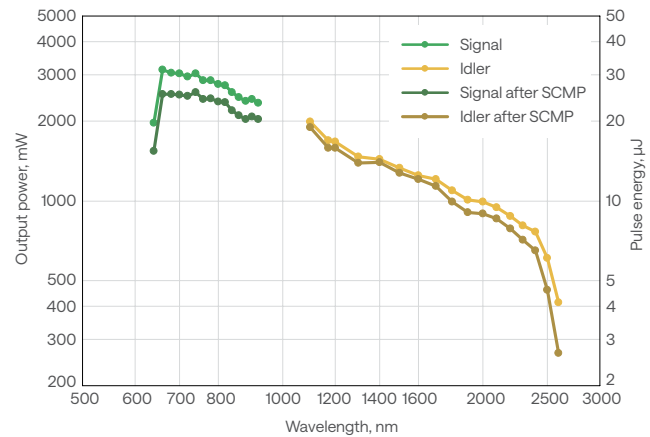

Specifications

Model	I-OPA-HP	I-OPA-F	I-OPA-ONE
Configuration	ORPHEUS	ORPHEUS-F	ORPHEUS-ONE
Pump power	Up to 40 W		
Pump pulse energy	20 – 400 μ J		
Repetition rate	Up to 2 MHz		
Tuning range ¹⁾	640 – 1010 nm (signal) 1050 – 2600 nm (idler)	650 – 920 nm (signal) 1200 – 2500 nm (idler)	1350 – 2000 nm (signal) 2100 – 4500 nm (idler)
Conversion efficiency	> 7% @ 700 nm (40 – 400 μ J pump; up to 1 MHz)		> 9% @ 1550 nm (40 – 400 μ J pump; up to 1 MHz)
	> 3.5% @ 700 nm (20 – 40 μ J pump; up to 2 MHz)		> 6% @ 1550 nm (20 – 40 μ J pump; up to 2 MHz)
Spectral bandwidth ²⁾	80 – 220 cm^{-1} @ 700 – 960 nm	200 – 1000 cm^{-1} @ 650 – 920 nm 150 – 1000 cm^{-1} @ 1200 – 2000 nm	60 – 150 cm^{-1} @ 1450 – 2000 nm
Pulse duration ²⁾³⁾	120 – 250 fs	< 55 fs @ 800 – 920 nm < 70 fs @ 650 – 800 nm < 100 fs @ 1200 – 2000 nm	100 – 300 fs
Long-term power stability, 8 h ⁴⁾	< 1% @ 800 nm		< 1% @ 1550 nm
Pulse-to-pulse energy stability, 1 min ⁴⁾	< 1% @ 800 nm		< 1% @ 1550 nm
Wavelength extension options	320 – 505 nm (SHS) ⁵⁾ 525 – 640 nm (SHI) ⁵⁾	Contact sales@lightcon.com	4500 – 10000 nm (DFG)
Pulse compression options ²⁾	n/a	SCMP (signal pulse compressor) ICMP (idler pulse compressor) GDD-CMP (compressor with GDD control)	n/a

PUMP LASER REQUIREMENTS

Pump laser	PHAROS or CARBIDE
Center wavelength	1030 \pm 10 nm
Maximum pump power	40 W
Maximum repetition rate	Up to 2 MHz
Pump pulse energy	20 – 400 μ J
Pulse duration	180 – 300 fs

ENVIRONMENTAL & UTILITY REQUIREMENTS

Operating temperature ⁶⁾	19 – 25 $^{\circ}$ C (air conditioning recommended)
Relative humidity ⁶⁾	20 – 70% (non-condensing)
Electrical requirements	n/a ⁷⁾

¹⁾ In case of fixed wavelength (FW), a single wavelength can be selected from the signal or idler range. The signal may have an accessible idler pair, and vice versa.

²⁾ I-OPA-F broad-bandwidth pulses are compressed externally. Typical pulse duration before compression: 120 – 250 fs, after compression: 25 – 70 fs @ 650 – 900 nm, 40 – 100 fs @ 1200 – 2000 nm.

³⁾ Output pulse duration depends on selected wavelength and pump laser pulse duration.

⁴⁾ Expressed as normalized root mean squared deviation (NRMSD).

⁵⁾ Conversion efficiency is 1.2% at peak; specified as a percentage of pump power.

⁶⁾ Specifications are guaranteed for a maximum temperature variation of \pm 1 $^{\circ}$ C and humidity variation of \pm 10%.

⁷⁾ I-OPA is powered by the same electrical source as the pump laser. Thus, refer to the pump laser electrical requirements.

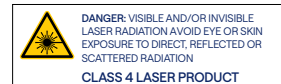

Drawings

CARBIDE-CB3 with I-OPA-HP drawing and output ports

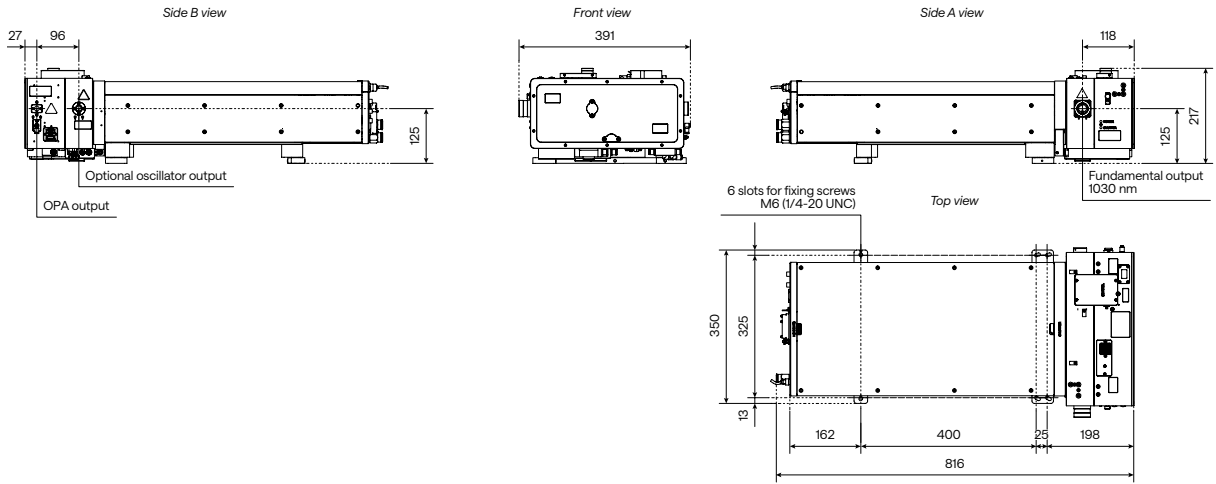

CARBIDE-CB5 with I-OPA-HP drawing and output ports

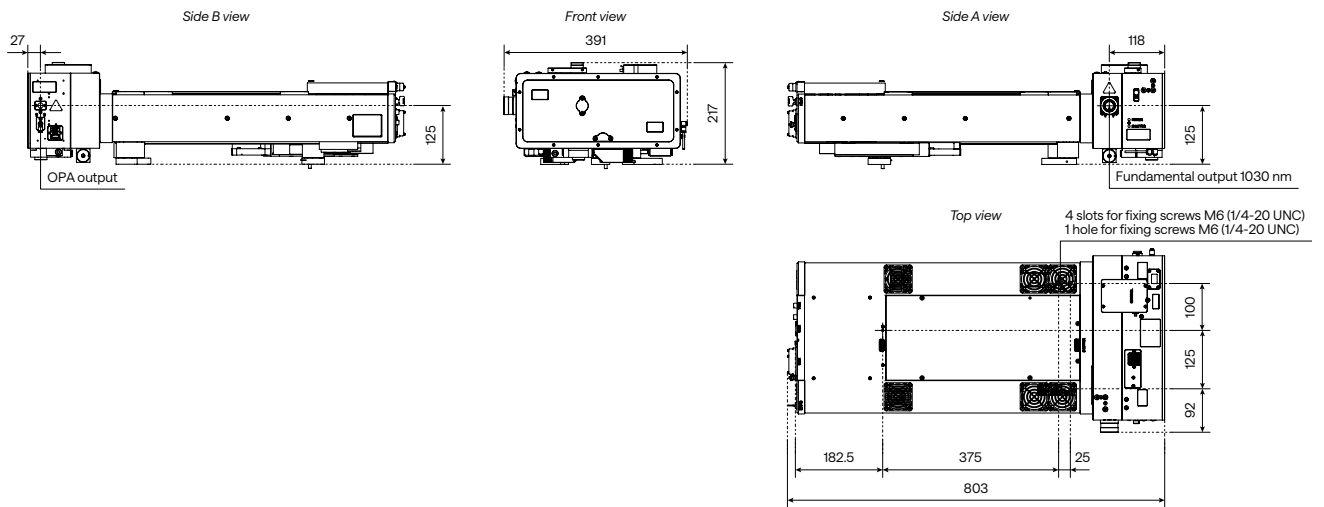

PHAROS-PH2 with I-OPA-HP drawing and output ports

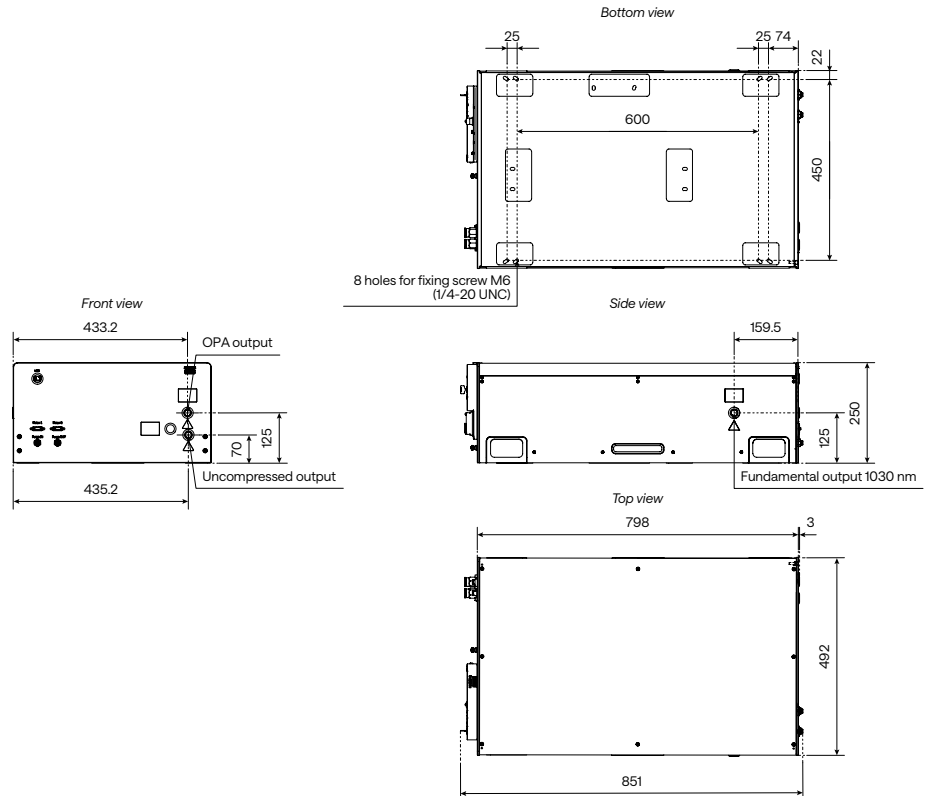

Micromachining Applications

LIGHT CONVERSION delivers best-in-class lasers for today's most demanding applications.

This section provides examples of micromachining driven by ultrafast light-matter interaction, including drilling, cutting, welding, surface structuring, and marking, for industries such as consumer electronics, semiconductors, medical, luxury goods, automotive & aerospace.

Cutting & drilling

Volume modification

Surface structuring

Selective ablation



Selective ablation of tungsten carbide.

High-contrast marking



Corrosion-free black-and-white marking on a stainless steel hemostatic clamp using the BiBurst option.

Brittle & highly thermally sensitive material cutting

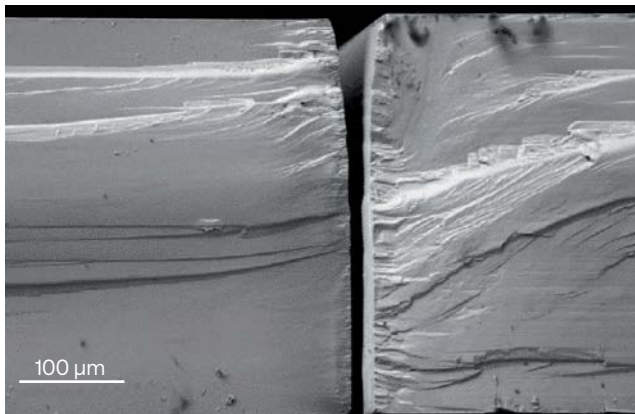

Multi-pass cadmium tungstate cutting. No cracks. All thermal trace effects eliminated.

Source: Micronanics Laser Solutions Centre.

Stainless steel stent cutting



Example of a stent cut from stainless steel.

Glass needle micro-drilling



Glass needle micro-drilling.

Source: Workshop of Photonics.

Steel drilling

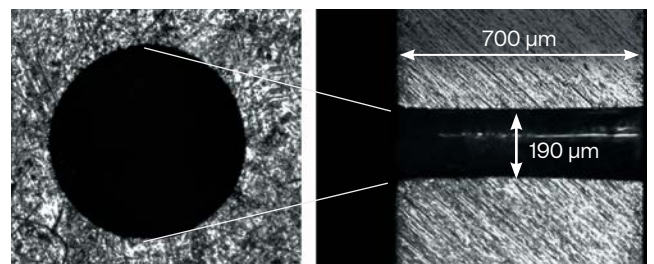

Taperless hole micro-drilling in stainless steel alloys.

Source: Workshop of Photonics.

Milling of complex 3D surfaces



3D-milled sample in copper. Zoom-in SEM image.

Source: A.Žemaitis, et al. Scientific Reports (2019).

Stainless steel polishing

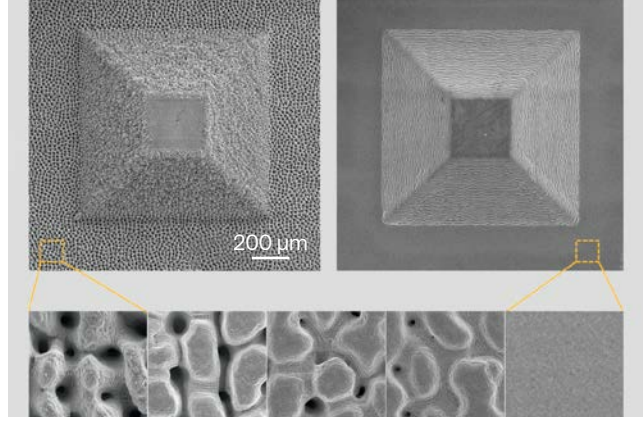

SEM images of structures ablated in stainless steel, before and after polishing using a GHz burst (from left to right).

Source: D.Metzner, et al. Applied Surface Science (2020).

Birefringent volume modification in glass



Form induced birefringence-retardance variation results in different colors in parallel-polarized light.

Source: Workshop of Photonics.

High-precision glass drilling

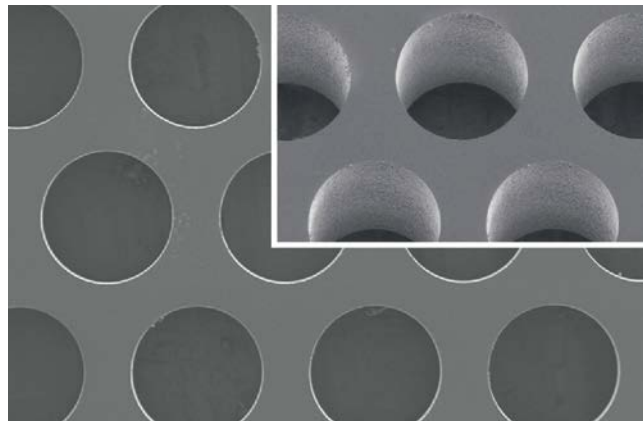

Glass micro-drilling, no taper.

Source: Workshop of Photonics.

3D glass etching



Structure fabricated in fused silica.

3D multi-photon polymerization

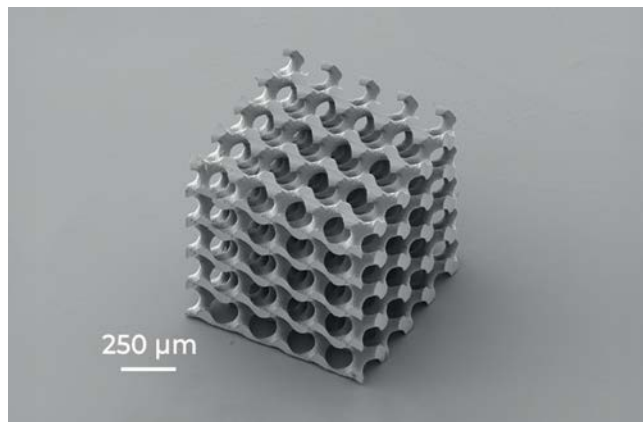

3D structure fabricated from SZ2080 polymer using multi-photon polymerization.

Source: Femtika.



Microfluidic channel ablation and welding

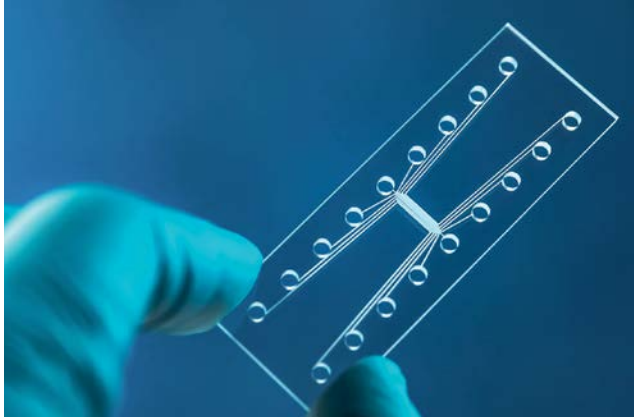

Microfluidic chip manufacturing with channel sealing.

Source: Workshop of Photonics.

3D waveguides

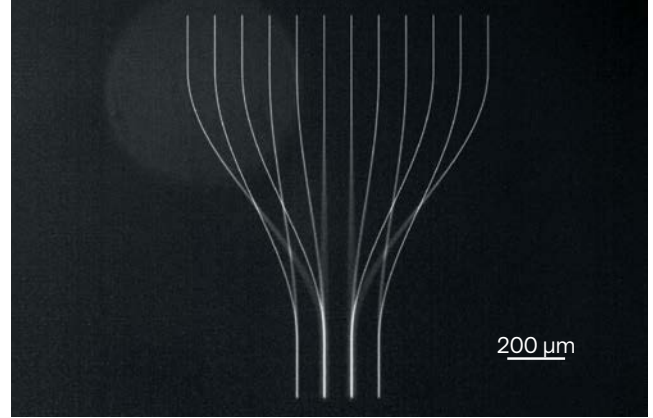

3D waveguides fabricated in fused silica.

Source: Workshop of Photonics.

Fiber cleaving

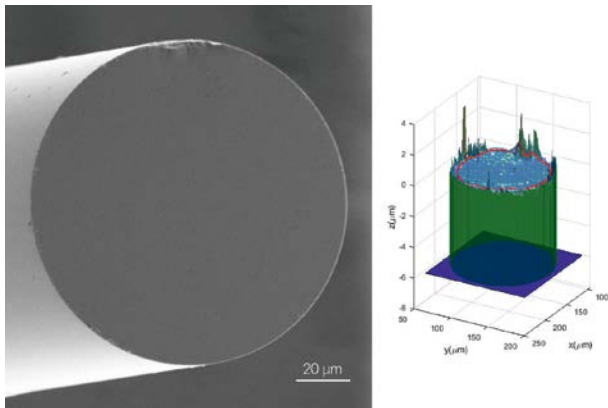

Fiber end-face after laser-based scribing (left) and its surface profile (right).

Source: Swinburne University of Technology.

Bragg grating waveguide (BGW) writing

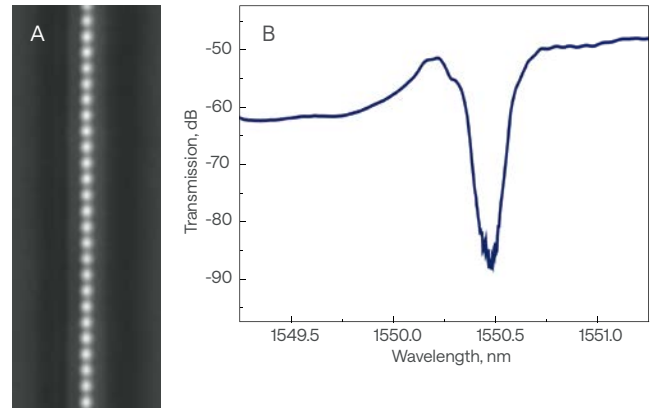

First-order Bragg gratings inscribed in a waveguide (a). Resonant spectral transmission of the inscribed BGW (b).

Source: G.Zhang, et al. Photon. Res. (2019).

SERS sensor fabrication

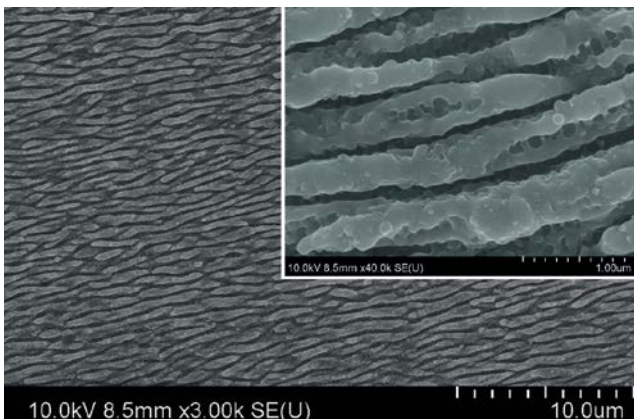

SEM image of the Ti-6Al-4V (TC4) surface after irradiation with a progressive laser scan.

Source: L.Lu, et al. Nanomaterials (2019).

Friction and wear reduction

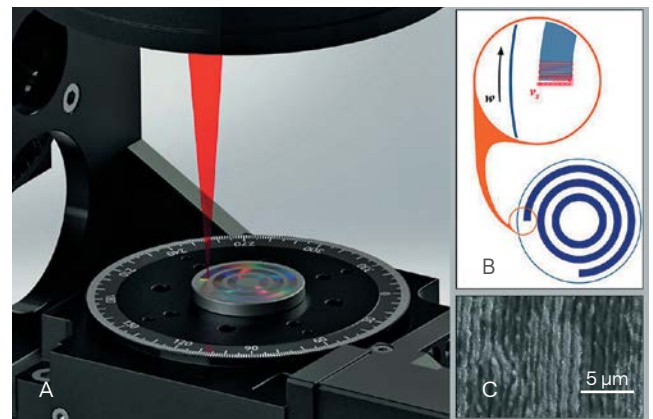

Schematic of the laser treatment (a), laser patterning strategy (b), SEM image of induced LIPSS (c).

Source: I.Gnilitskiy, et al. Lubricants (2019).

Intraocular lens cutting



Laser-cut intraocular lens.

Source: LASEA.

Silicon Carbide dicing



Single-pass (300 mm/s) dicing of a 500 μm thick 4H-SiC wafer.

Cutting and welding



Cut and welded parts from brass using a single laser system.

Silicon dicing



Precise dicing of a silicon wafer.

Surface texturing



Moon-like surface texturing on a watch bezel.

Source: LASEA.

Nozzle drilling



Precision drilling of the nozzle holes.



Global Representative Network

AUSTRALIA NEW ZEALAND	Lastek Pty Ltd. Adelaide, Australia Phone: +61 8 84 438 668 ricardas@lastek.com.au www.lastek.com.au	ISRAEL	ROSH Electroptics Ltd. Natanya, Israel Phone: +972 (0)9 862 7401 info@roshelop.co.il www.roshelop.co.il
BELGIUM, NETHERLANDS, LUXEMBOURG	Laser 2000 Benelux C.V. Vinkeveen, Netherlands Phone: +31 297 266191 info@laser2000.nl www.laser2000.nl	ITALY	Optoprim S.r.l. Vimercate, Italy Phone: +39 039 834 977 info@optoprim.it www.optoprim.it
BRAZIL	Photonics Ltda São Paulo, Brazil Phone: +55 11 2839 3209 info@photonics.com.br www.photonics.com.br	JAPAN	Phototechnica Corp. Saitama, Japan Phone: +81 48 871 0067 voc@phototechnica.co.jp www.phototechnica.co.jp
CZECH REPUBLIC, SLOVAKIA	Femtonika s.r.o. Zbýšov, Czech Republic Phone: +420 792 417 400 info@femtonika.cz www.femtonika.cz	KOREA	Light Conversion Korea Daejeon, Korea Phone: +82 42 368 1010 jungsik.seo@lightcon.com
CHINA	Light Conversion China Shenzhen, China Phone: +86 189 4874 5558 sales.china@cn.lightcon.com	POLAND	Amecam Warszawa, Poland Phone: +48 602 500 680 amecam@amecam.pl www.amecam.pl
	Beijing Light-Quantum Technology Co., Ltd. Beijing, China Phone: +86 10 8290 0415 sales@light-quantum.cn www.light-quantum.cn	SINGAPORE	Acexon Technologies Pte Ltd. Singapore Phone: +65 6565 7300 sales@acexon.com www.acexon.com
	Genuine Optronics Limited Shanghai, China Phone: +86 21 64 325 169 jye@gen-opt.com www.gen-opt.com	SPAIN, PORTUGAL	Innova Scientific S.L. Las Rozas de Madrid, Spain Phone: +34 91 710 56 50 rafael.pereira@innovasci.com www.innovasci.com
FRANCE, SWITZERLAND, BELGIUM	Jean-François Poisson Industrial Market Development Manager Phone: +33 674 48 0778 jf.poisson@lightcon.com	SWITZERLAND	GMP SA Renens, Switzerland Phone: +41 21 633 21 21 info@gmp.ch www.gmp.ch
FRANCE	Frédéric Berthillier Scientific Market Development Manager Phone: +33 745 014 410 frederic.berthillier@lightcon.com	TAIWAN	Alaser Co. Ltd. Taipei, Taiwan Phone: +886 2 2377 3118 alexfu@alaser.com.tw www.alaser.com.tw
GERMANY, AUSTRIA, SWITZERLAND	Ulrich Höchner Industrial Market Development Manager Phone: +49 157 8202 5058 u.hoechner@lightcon.com	TURKEY	Innova Teknoloji Ltd. İstanbul, Turkey Phone: +90 216 315 03 36 eryetistir@innova-teknoloji.com www.innova-teknoloji.com
GERMANY, AUSTRIA	Christian Hellwig Scientific Market Development Manager Phone: +49 174 204 9053 christian.hellwig@lightcon.com	UNITED KINGDOM	Photonic Solutions Ltd. Edinburgh, UK Phone: +44 (0) 131 664 8122 ben.agate@photonicsolutions.co.uk www.photonicsolutions.co.uk
	Stefan Piontek Scientific Market Development Manager Mobile +49 176 8345 7119 stefan.piontek@lightcon.com	USA, CANADA	Light Conversion-USA, Inc. Bozeman, MT, USA Phone: +1 833 685 2872 saleslc@lightcon-usa.com
INDIA	Anatech Laser Instruments Pvt. Ltd. Mumbai, India Phone: +91 22 4121 0001 / 02 / 03 sales@anatechlaser.com www.anatechlaser.com		

Lost in calculations?

Try interactive calculators for
scientists & engineers

Optics Toolbox

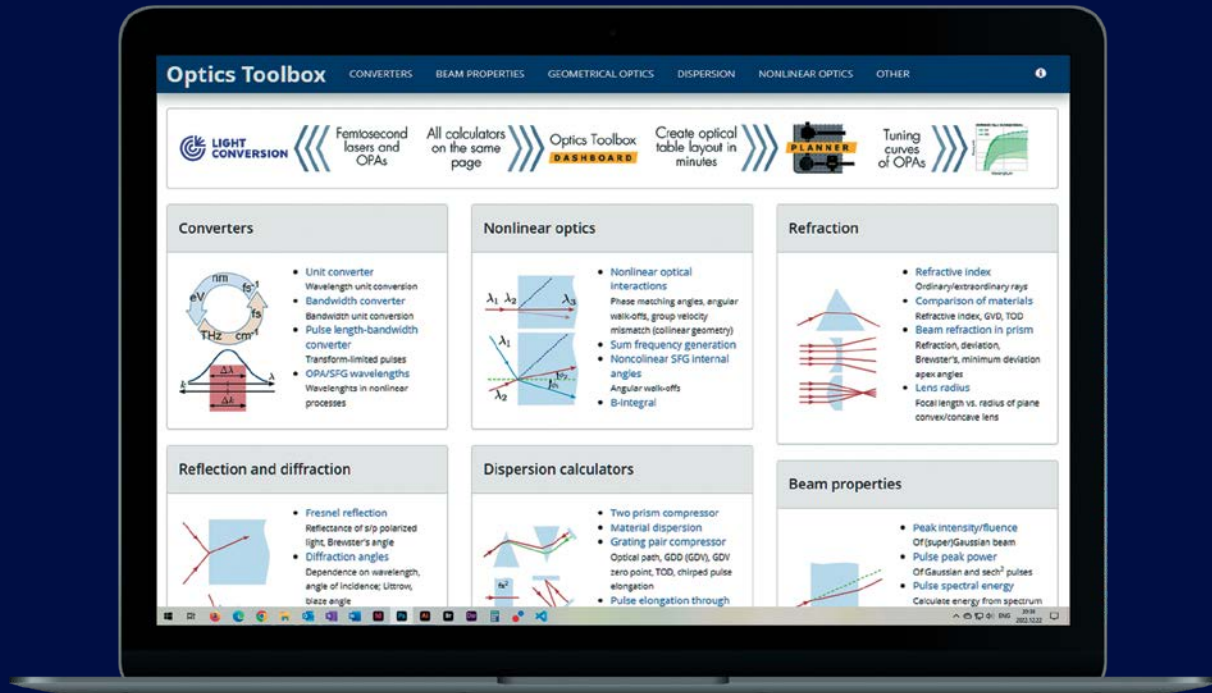

toolbox.lightcon.com

All calculators on the same page

Optical table layout planner

Custom OPA tuning curves



LIGHT CONVERSION CHINA

702-1, F1 Building, TCL Science Park, No.1001
Zhongshanyuan Road, Nanshan Dist., Shenzhen, China
Phone: +86 189 4874 5558
sales.china@cn.lightcon.com

LIGHT CONVERSION KOREA

520-ho, 65, Techno 3-ro,
Yuseong-gu, Daejeon, 34016, Korea
Phone: +82 42 368 1010
jungsik.seo@lightcon.com

LIGHT CONVERSION

Keramiku 2B, LT-10233 Vilnius, Lithuania

Tel.: +370 5 2491830
Website: www.lightcon.com
Sales: sales@lightcon.com
Service: service@lightcon.com

LIGHT CONVERSION USA, INC

619 N Church Ave, Unit #3
Bozeman, MT 59715
Phone: +1 833 685 2872
Fax: +1 833 395 2872
sales@lightcon-usa.com



toolbox.lightcon.com