

ORPHEUS-IV

Non-Collinear Optical Parametric Amplifier



FEATURES

- < 30 fs pulse duration
- Integrated prism compressor
- Adjustable bandwidth and pulse duration
- Single pulse – 1 MHz repetition rate
- Computer controlled

ORPHEUS-N is a non-collinear optical parametric amplifier (NOPA) pumped by Ytterbium based femtosecond laser amplifier. Depending on the ORPHEUS-N model, it has a built in second or third harmonic generator producing 515 nm or 343 nm pump. ORPHEUS-N with second harmonic pump (ORPHEUS-N-2H) delivers pulses of less than 30 fs in the 700–850 nm range with average power of more than 0.5 W at 700 nm¹⁾. ORPHEUS-N with third harmonic pump (ORPHEUS-N-3H) delivers pulses of less than 30 fs in the 530–670 nm range with average power of more than 0.2 W at 550 nm. ORPHEUS-N works at repetition rates of up to 1 MHz. The device is equipped with computer

controlled stepping motor stages, allowing automatic tuning of the output wavelength. An optional signal's second harmonic generator is also available, extending the tuning range down to 250–450 nm. Featuring a state of the art built in pulse compressor ORPHEUS-N is an invaluable instrument for time-resolved spectroscopy. More than one ORPHEUS-N systems can be operated simultaneously with a single amplifier providing several pump and/or probe channels with independent wavelength tuning.

¹⁾ When pumped with 6 W @ 1030 nm, 200 kHz.

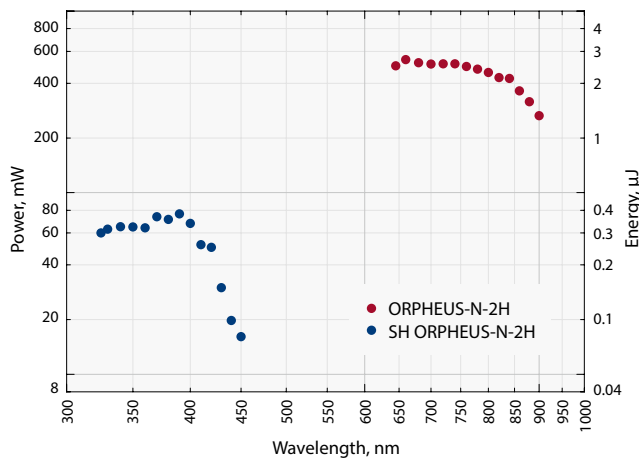

ORPHEUS-IV-2H

Typical tuning curve of ORPHEUS-N-2H
Pump: 6 W, 30 μJ, 200 kHz

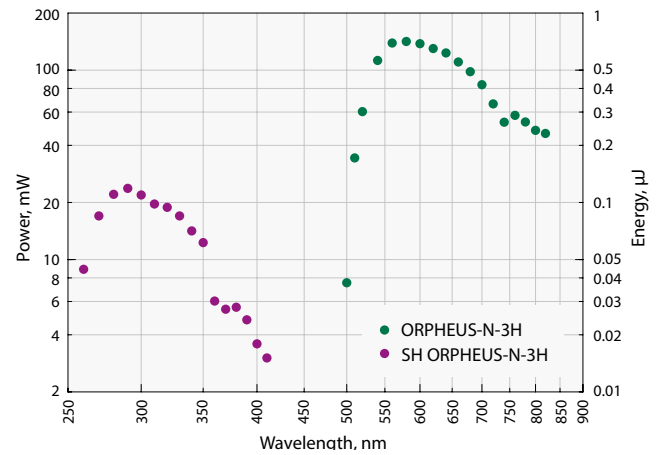

ORPHEUS-IV-3H

Typical tuning curve of ORPHEUS-N-3H
Pump: 6 W, 30 μJ, 200 kHz

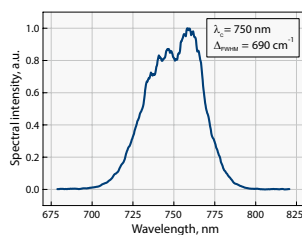

Typical output of ORPHEUS-N-2H

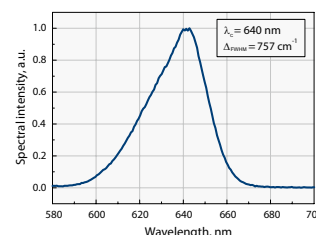
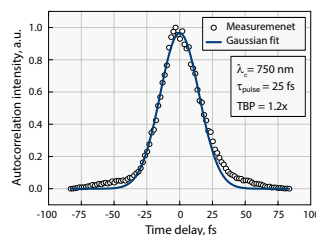

Typical output of ORPHEUS-N-3H

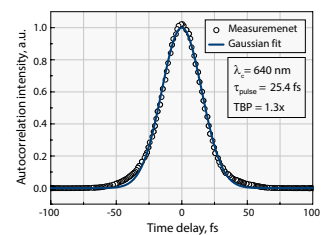

For custom tuning curve value visit <http://toolbox.lightcon.com/tools/tuningcurves/>

SPECIFICATIONS

Product name	<i>ORPHEUS-N-2H</i>		<i>ORPHEUS-N-3H</i>		
OUTPUT FROM ORPHEUS-N					
Tuning range	650 – 900 nm (Signal)		520 – 900 nm (Signal)		
Integrated second (third) harmonic generation efficiency	> 35 % (515 nm)		> 25 % (343 nm)		
Pump power (maximum)	8 W				
Pump pulse energy	10 – 200 μ J		12 – 200 μ J		
Conversion efficiency at peak	700 nm	800 nm	580 nm	700 nm	800 nm
	> 7 %	> 5 %	> 1.3 %	> 0.7 %	> 0.3 %
Pulse duration after compressor	< 30 fs (700 – 850 nm)		< 30 fs (530 – 670 nm) < 80 fs (670 – 900 nm)		
Long term power stability (8 h)	< 2 % @ 800 nm				
Pulse energy stability (1 min)	< 2 % @ 800 nm				
WAVELENGTH EXTENSIONS					
Tuning range (SH of Signal)	325 – 450 nm		260 – 450 nm		
Conversion efficiency at peak	> 10 % of Signal				

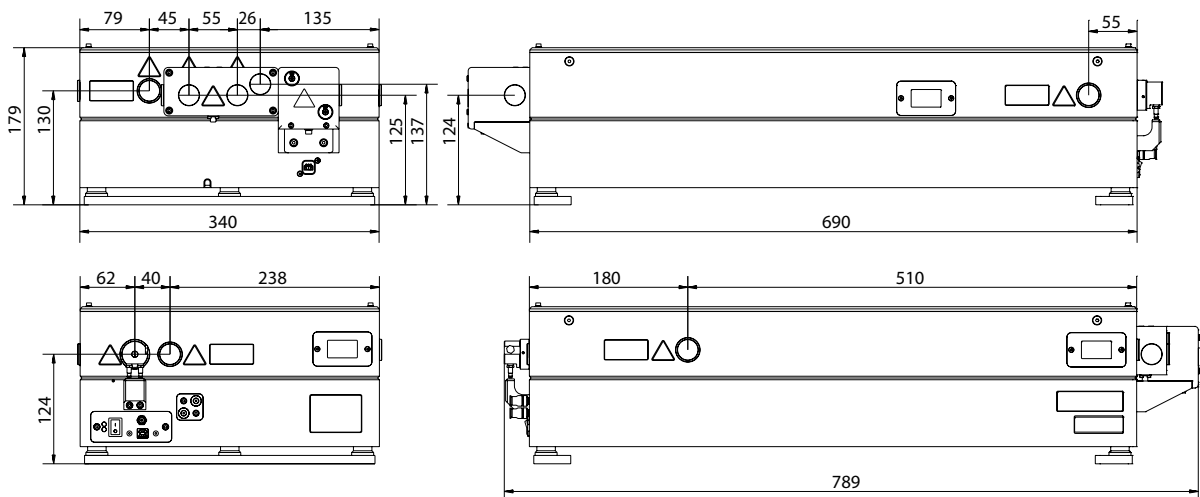

ORPHEUS-N outline drawings



ORPHEUS-N setup example