

CARBIDE

Femtosecond Lasers for Industry and Science



FEATURES

- < 290 fs – 10 ps tunable pulse duration
- > 800 μJ pulse energies
- > 80 W output power
- 60 – 2000 kHz tunable base repetition rate
- Includes pulse picker for pulse-on-demand operation
- Rugged, industrial-grade mechanical design
- Air or water cooling
- Automated harmonics generators (515 nm, 343 nm, 257 nm)
- Scientific interface enhancing system flexibility



CARBIDE-CB3

CARBIDE femtosecond lasers feature an output power of >80 W at 1030 nm wavelength. The laser emits pure pulses with ASE background of $<10^{-9}$ and recently updated maximum energy specifications without compromises to the beam quality, industrial grade reliability and beam stability regardless of environmental conditions. Continuously tunable repetition rate in a range of 60 kHz to 2 MHz is combined with an in-built Pulse Picker for output pulse timing and full-scale energy control with <10 microsecond response time, enabling

arbitrary shaping of the emission. Pulse duration can be tuned in a range of 290 fs – 10 ps. Excellent power stability of <0.5 % RMS is standard. The laser output can be split into a burst of several pulses of pico- and nano- separation while having the ability to modify the burst envelope. Harmonic generator options permit femtosecond applications at different wavelengths. The parameters are entirely software adjustable.

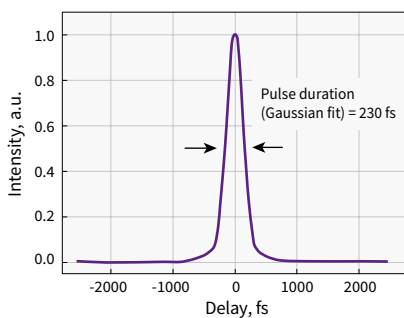

Typical pulse duration of CARBIDE laser

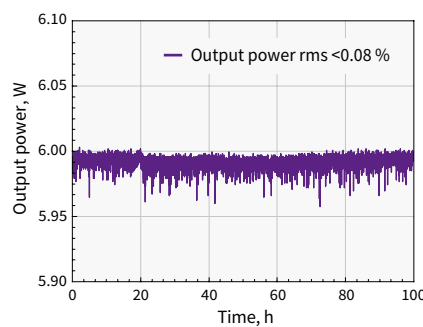

Long term power stability of CARBIDE-CB5

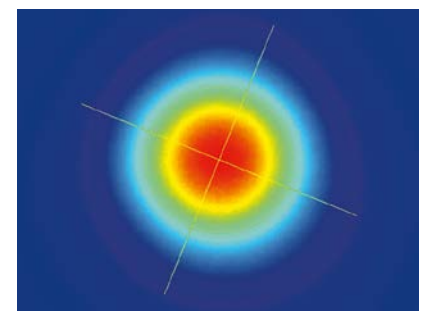

Typical beam profile of CARBIDE-CB5.
60 kHz, 5 W

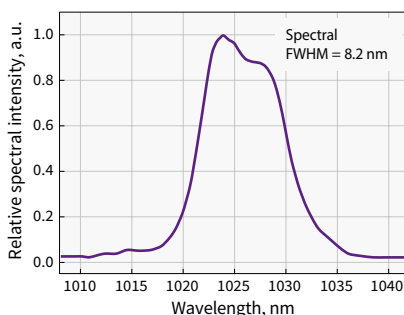

Typical spectrum of CARBIDE laser

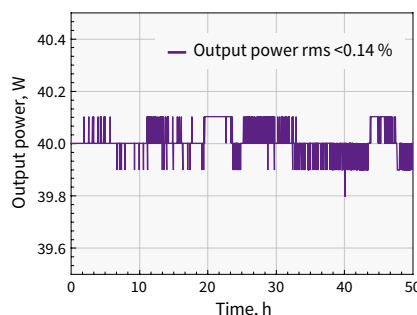

Long term power stability of CARBIDE-CB3

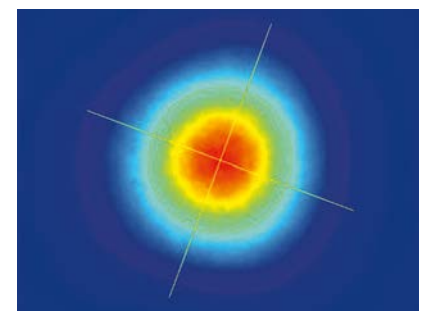

Typical beam profile of CARBIDE-CB3

SPECIFICATIONS

Model	CB3-40W	CB3-80W	NEW	CB5
-------	---------	---------	-----	-----

OUTPUT CHARACTERISTICS

Cooling method	Water-cooled		Air-cooled ¹⁾	
Max. average power	> 40 W	> 80 W	> 6 W	> 5 W
Pulse duration (assuming Gaussian pulse shape)	< 290 fs			
Pulse duration adjustment range	290 fs – 10 ps			
Max. pulse energy	> 0.4 mJ	> 0.8 mJ	> 100 μJ	> 83 μJ
Fundamental repetition rate ²⁾	100 – 2000 kHz		60 – 1000 kHz	
Pulse selection	Single-shot, Pulse-on-Demand, any base repetition rate division			
Centre wavelength ³⁾	1030 ± 10 nm			
Polarization	Linear, vertical			
Beam quality	TEM ₀₀ ; M ² < 1.2			
Pulse-to-pulse energy stability ⁴⁾	RMS deviation ⁵⁾ < 0.5 % over 24 hours			
Output power stability	RMS deviation ⁵⁾ < 0.5 % over 100 h			
Beam pointing stability	< 20 μrad/°C			
Pulse picker	FEC ⁶⁾	included	included	included, enhanced contrast AOM ⁷⁾
Pulse picker leakage	< 0.5 %	< 2 %	< 2 %	< 0.1 %

OPTIONAL EXTENSIONS

Harmonics generator	Integrated, optional (see page 14)			
Output wavelength	515 nm, 343 nm, 257 nm			
Optical parametric amplifier	Integrated, optional (see page 15)			
Tuning range	640 – 4500 nm			
BiBurst mode	Tunable GHz and MHz burst with burst-in-burst capability, optional (see page 9)			
GHz-mode (P)				
Intra burst pulse separation	~ 440 ± 40 ps ⁸⁾			
Max no. of pulses	1 . . 10 ⁹⁾		n/a	
MHz-mode (N)				
Intra burst pulse separation	~ 16 ns			
Max no. of pulses	1 . . 10			

PHYSICAL DIMENSIONS

Laser head	632 (L) × 305 (W) × 173 (H) mm	631 (L) × 324 (W) × 167 (H) mm
Power supply	280 (L) × 144 (W) × 49 (H) mm	220 (L) × 95 (W) × 45 (H) mm
Chiller	590 (L) × 484 (W) × 267 (H) mm	Not required

ENVIRONMENTAL & UTILITY REQUIREMENTS

Operating temperature	15 – 30 °C (59 – 86 °F)		17 – 27 °C (62 – 80 °F)	
Relative humidity	< 80 % (non condensing)			
Electric	110 – 220 VAC, 50 – 60 Hz			
Rated power	600 W	1000 W	300 W	
Power consumption	500 W	700 W	150 W	

¹⁾ Water-cooled version available on request.

²⁾ Lower repetition rates are available by controlling pulse picker.

³⁾ Precise wavelengths for specific models available upon request. 2nd (515 nm) and 3rd (343 nm) harmonic output also available.

⁴⁾ Under stable environmental conditions.

⁵⁾ Normalized to average pulse energy.

⁶⁾ Provides fast energy control; external analog control input available. Response time – next available RA pulse.

⁷⁾ Provides fast amplitude control of output pulse train.

⁸⁾ Custom spacing on request.

⁹⁾ Maximum number of pulses in a burst is dependent on the laser repetition rate. Custom number of pulses on request.

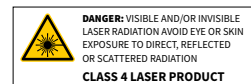

STABILITY MEASUREMENTS

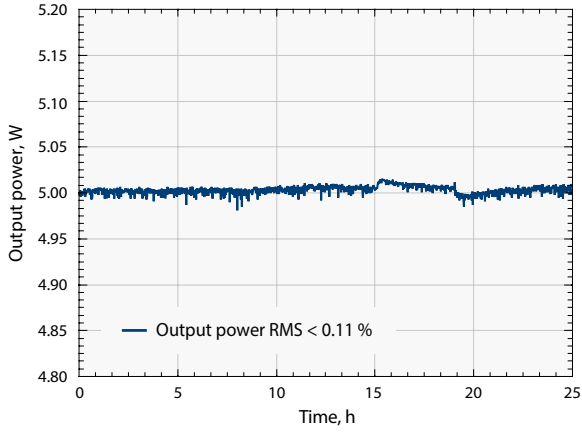

Output power under harsh environment conditions of CARBIDE-CB5

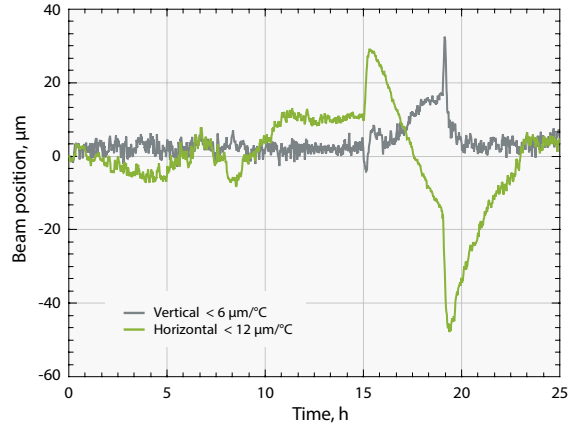

Beam position under harsh environment conditions of CARBIDE-CB5

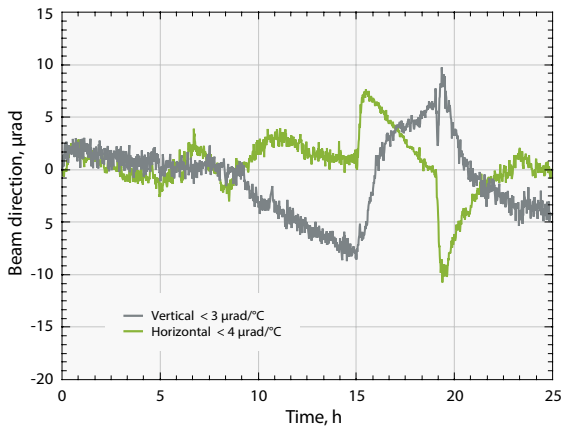

Beam direction under harsh environment conditions of CARBIDE-CB5

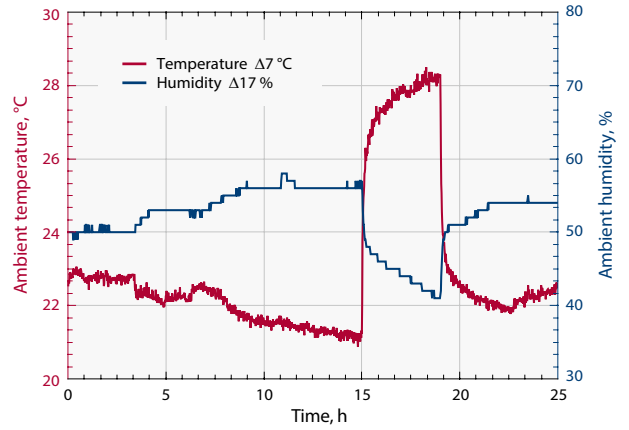

Harsh environment conditions of CARBIDE-CB5

OUTLINE DRAWINGS

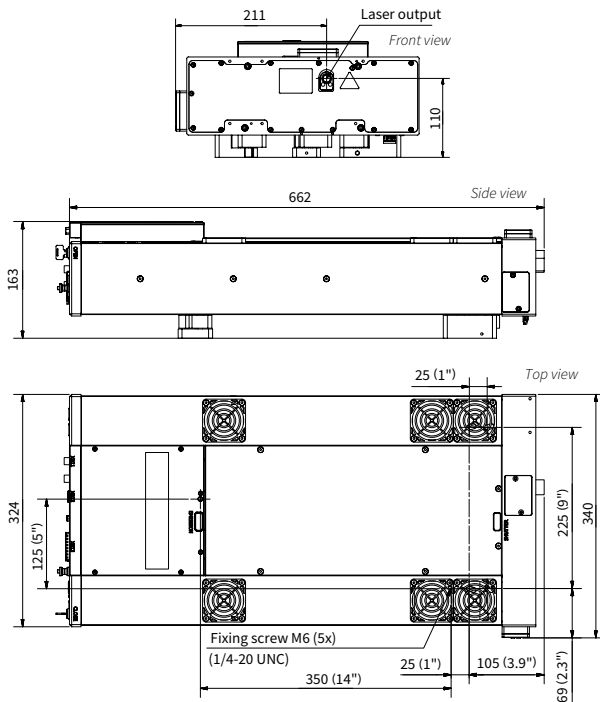

Outline drawing of air-cooled CARBIDE-CB5 with attenuator

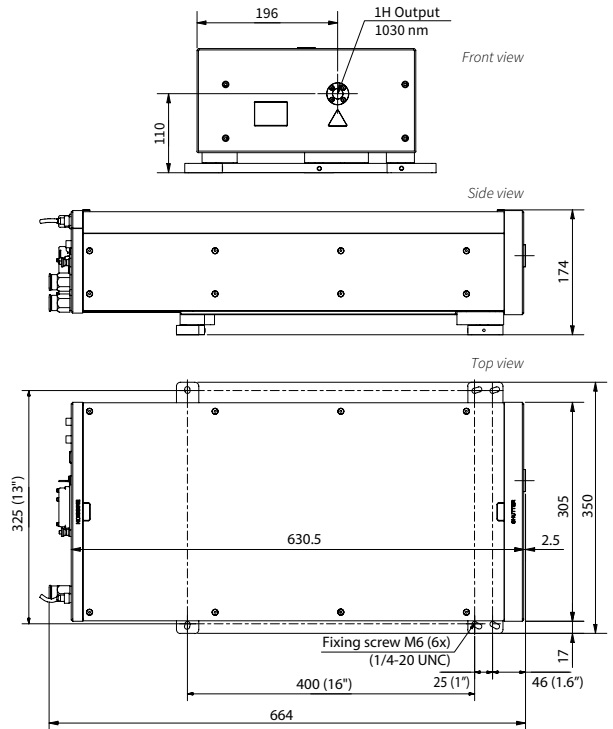

Outline drawing of CARBIDE-CB3

BiBurst

Tunable GHz and MHz burst with burst-in-burst capability

PHAROS and CARBIDE 40W (CB3) have an option for tunable GHz and MHz burst with burst-in-burst capability – called BiBurst. The distance between burst packet groups is called nanosecond burst, N (MHz-Burst). The distance between sub-pulses in the group is called picosecond burst, P (GHz-Burst).

In single pulse mode, one pulse is emitted at a time at some fixed frequency. In burst mode, the output consists of several picosecond burst packets each separated by an equal time period between each packet. Each packet can contain a number of sub-pulses which are also separated by an equal time period between each pulse.

High pulse energy femtosecond lasers PHAROS and CARBIDE with flexible BiBurst functionality bring new production capabilities to high-tech manufacturing industries such as consumer electronics, integrated photonic chip manufacturing, stent cutting, surface functionalization, future displays manufacturing and quantum computing.

BiBurst material fabrication areas cover:

- brittle material drilling and cutting
- deep engraving
- selective ablation
- transparent materials volume modification
- hidden marking
- surface functional structuring.

SPECIFICATIONS

Model		CARBIDE-CB3 (40 W)	PHAROS	PHAROS-SP
P, GHz-mode	Intra burst pulse separation ¹⁾	~440 ± 40 ps	~200 ± 40 ps	~500 ± 40 ps
	Max no. of pulses ²⁾	1 .. 10	1 .. 25	1 .. 10
N, MHz-mode	Intra burst pulse separation	~16 ns		
	Max no. of pulses	1 .. 10	1 .. 9, (7 with FEC)	1 .. 9, (7 with FEC)

¹⁾ Custom spacing on request.

²⁾ Maximum number of pulses in a burst is dependent on the laser repetition rate. Custom number of pulses on request.

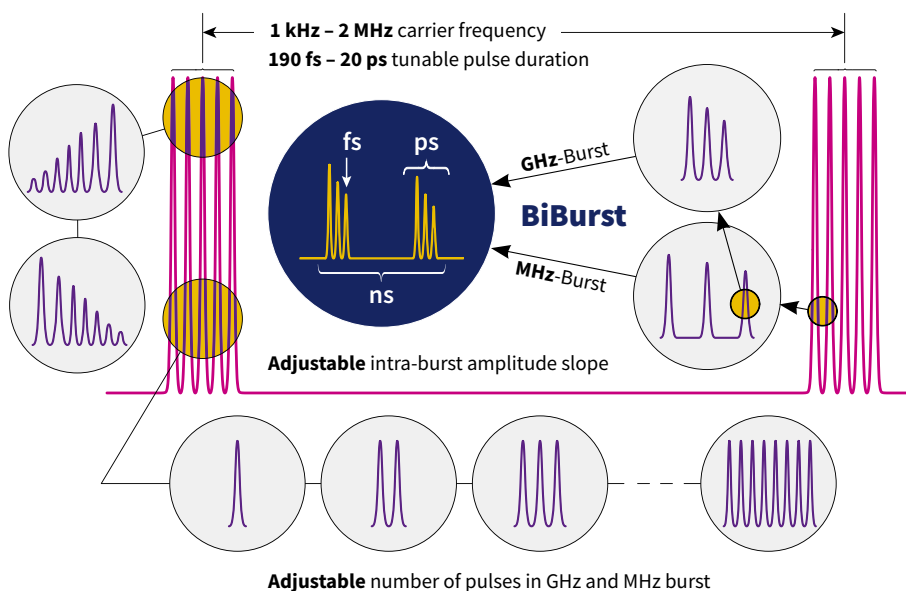

SCI-M | CARBIDE

Scientific Interface Module for CARBIDE

FEATURES

- Laser seeding via external OSC (FLINT)
- Uncompressed laser output access
- Provides simultaneous OSC output (~65 Mhz, <100 fs, >100 mW output power)
- Beam-splitting options



The CARBIDE scientific interface module is an optional laser add-on which extends the flexibility of industrial-grade laser configurations and makes it particularly attractive to scientific applications. This module incorporates multiple options which include a simultaneous or separate oscillator output, a second compressed or uncompressed main amplifier output and

seeding by an external oscillator. For example, it can be seeded by another CARBIDE laser with its own oscillator, thus ensuring precise optical synchronization between two lasers. All the mentioned amplifier outputs can be equipped with motorized power attenuators and all options are compatible in-between.

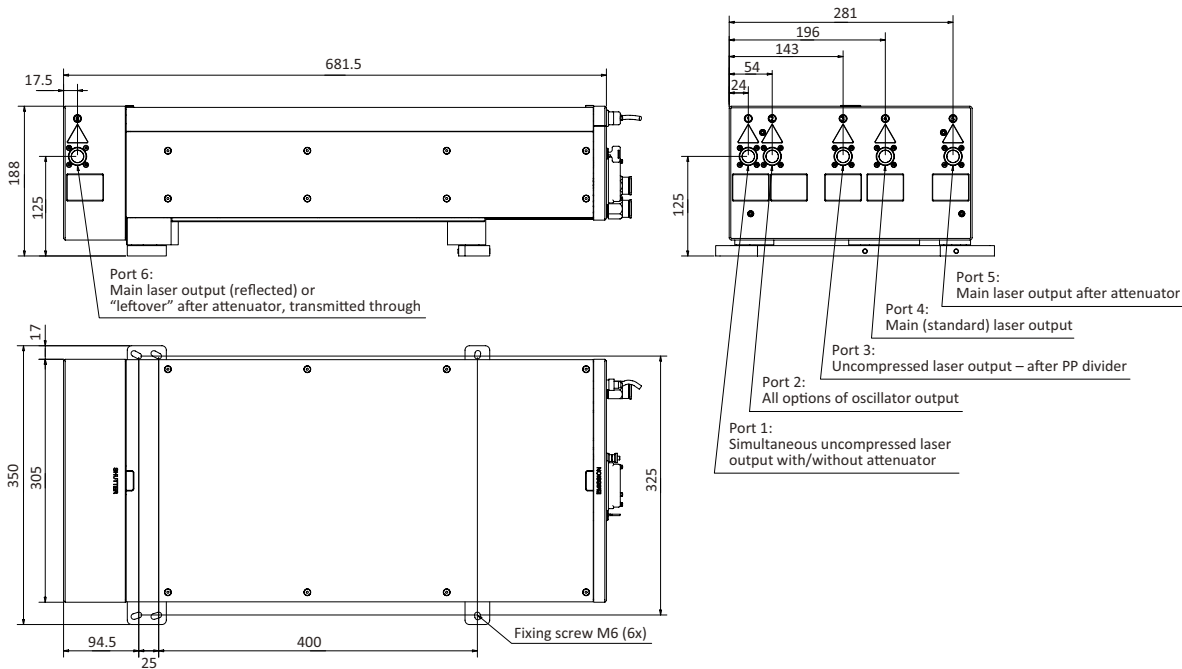

Outline drawing of CARBIDE-CB3-40-200 with scientific interface

HG | CARBIDE

Automated Harmonics Generators

FEATURES

- 515 nm, 343 nm and 257 nm
- Output selection by software
- Mounted directly on a laser head and integrated into the system
- Rugged, industrial-grade mechanical design



Harmonics generator module attached to air-cooled CARBIDE-CB5

CARBIDE laser can be equipped with automated harmonics modules. Selection of fundamental (1030 nm), second (515 nm), third (343 nm) or fourth (257 nm) harmonics outputs

are available by software control. Harmonics generators are designed to be used in industrial applications where a single output wavelength is desired.

SPECIFICATIONS

Model	2H	2H-3H	2H-4H
Output wavelength ¹⁾ (automated selection)	1030 nm 515 nm	1030 nm 515 nm 343 nm	1030 nm 515 nm 257 nm
Input pulse energy	20 – 800 μJ	50 – 800 μJ	20 – 800 μJ
Pump pulse duration	< 300 fs		
Conversion efficiency	> 50 % (2H)	> 50 % (2H) > 25 % (3H)	> 50 % (2H) > 10% (4H) ²⁾
Beam quality (M ²) ≤ 400 μJ pump	< 1.3 (2H), typical < 1.15	< 1.3 (2H), typical < 1.15 < 1.4 (3H), typical < 1.2	< 1.3 (2H), typical < 1.15 n/a (4H)
Beam quality (M ²) > 400 μJ pump	< 1.4 (2H)	< 1.4 (2H) < 1.5 (3H)	< 1.4 (2H) n/a (4H)

¹⁾ Depends on pump laser model.

²⁾ Maximum output power 1 W.

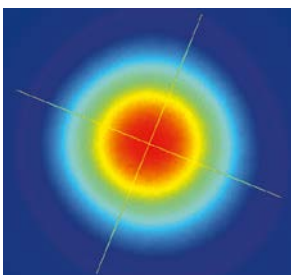
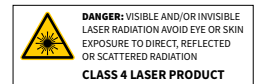

Typical 1H beam profile of CARBIDE-CB5, 60 kHz, 5 W

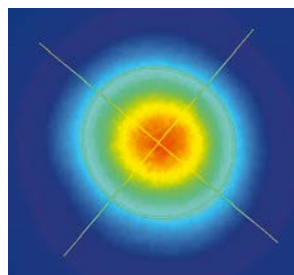

Typical 2H beam profile of CARBIDE-CB5, 100 kHz, 3.4 W

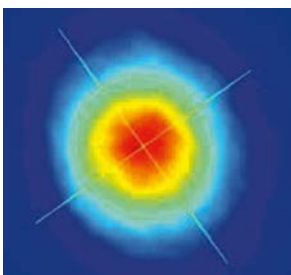

Typical 3H beam profile of CARBIDE-CB5, 100 kHz, 2.2 W

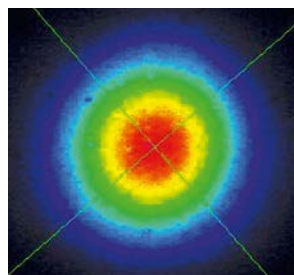

Typical 4H beam profile of CARBIDE-CB5, 100 kHz, 100 mW

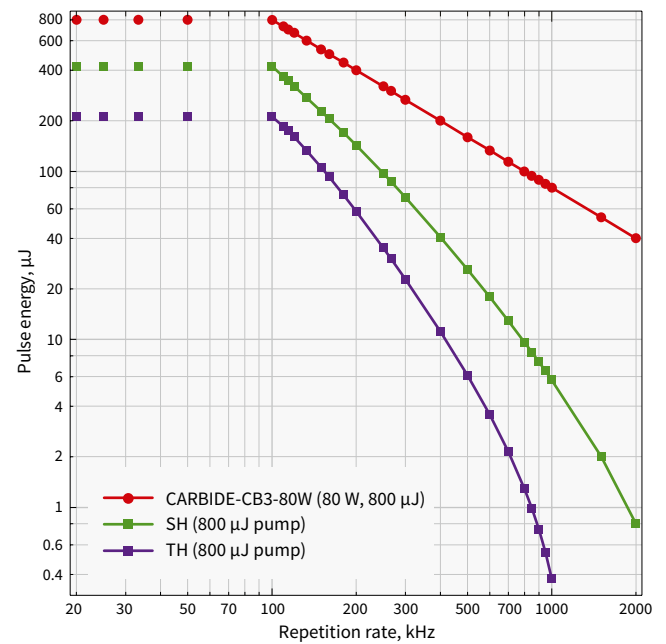

Harmonics energy vs pulse repetition rate for CARBIDE-CB3-80W

I-OPA

Industrial-grade Optical Parametric Amplifier



FEATURES

- Automatically tunable or fixed wavelength options
- Robust, integrated mechanical design
- Plug and play installation
- User friendly operation
- Up to 2 MHz repetition rate, down to single shot operation
- Up to 40 W pump power
- Short pulse duration option (< 100 fs)
- Integrated tunable beam splitter for pump laser beam



Tunable I-OPA-TW module attached to air-cooled CARBIDE-CB5

I-OPA series of optical parametric amplifiers marks a new era of simplicity in the world of tunable wavelength femtosecond light sources. Based on 10 years of experience producing the ORPHEUS series of optical parametric amplifiers, this solution brings together the flexibility of tunable wavelength with robust industrial-grade design. The original I-OPA is a rugged module attached to our PHAROS laser, providing long term stability comparable to that of the industrial harmonics modules. The new and improved tunable version is designed to be coupled with our PHAROS and CARBIDE series femtosecond lasers and primarily intended to be used with spectroscopy or microscopy applications that demand high stability. The -HP model is targeted to be coupled with our HARPIA series as a pump beam source for ultrafast pump-probe spectroscopy. The -F model is primarily designed to be used as a light source in multiphoton microscopy devices. The -ONE model will be useful in the field of mid-IR spectroscopy, as well as other applications where higher pulse energy is required in the infrared part of the spectrum. All of these models can be used for micromachining and other

industrial applications; the tunable version suited to be the ideal R&D system, while the fixed wavelength I-OPA would be the cost-effective solution for large scale production.

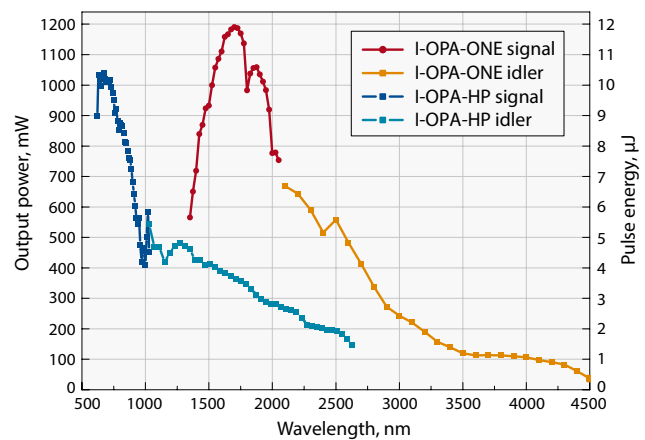

Typical I-OPA module energy conversion curves.
Pump: PHAROS-10W, 100 µJ, 100 kHz

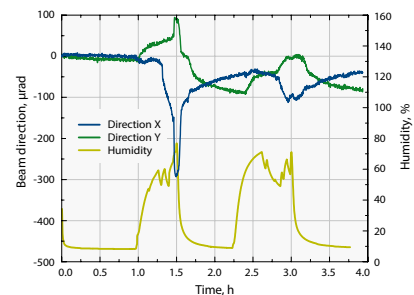
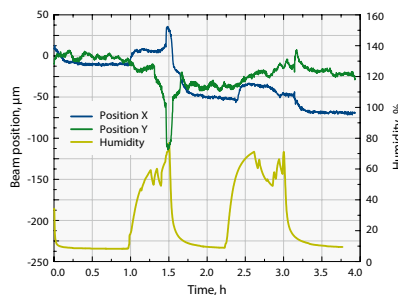
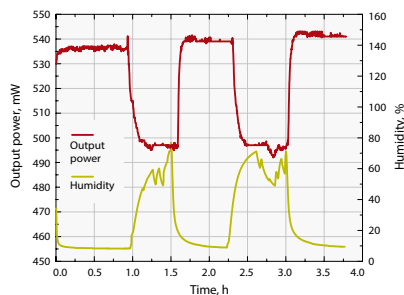

Fixed wavelength I-OPA-FW beam pointing and output power measurements under harsh environment conditions (humidity and temperature cycling)

SPECIFICATIONS OF TUNABLE I-OPA

Model	I-OPA-TW-HP	I-OPA-TW-F	I-OPA-TW-ONE
Based on ORPHEUS model	ORPHEUS	ORPHEUS-F	ORPHEUS-ONE
Pump power	Up to 40 W		
Pump pulse energy	10 – 400 μ J		20 – 400 μ J
Pulse repetition rate	Up to 2 MHz		
Tuning range, signal	640 – 1010 nm	650 – 900 nm	1350 – 2060 nm
Tuning range, idler	1050 – 2600 nm	1200 – 2500 nm	2060 – 4500 nm
Conversion efficiency at peak, signal wavelength	> 7 % @ 700 nm		> 9 % @ 1550 nm
Additional options	n/a	SCMP: Signal pulse compressor ICMP: Idler pulse compressor PCMP: pre-chirp dispersion compensator	n/a
Pulse bandwidth ¹⁾	80 – 220 cm^{-1} @ 700 – 960 nm	200 – 750 cm^{-1} @ 650 – 900 nm 150 – 500 cm^{-1} @ 1200 – 2000 nm	60 – 150 cm^{-1} @ 1450 – 2000 nm
Pulse duration ²⁾	120 – 250 fs	< 55 fs @ 800 – 900 nm < 70 fs @ 650 – 800 nm < 100 fs @ 1200 – 2000 nm	100 – 300 fs
Wavelength extension options	SHS: 320 – 505 nm SHI: 525 – 640 nm Conversion efficiency 1.2% at peak	Contact sales@lightcon.com	DFG: 4500 – 10000 nm ³⁾
Applications	Micro-machining Microscopy Spectroscopy	Nonlinear microscopy Ultrafast spectroscopy	Mid-IR spectroscopy AFM microscopy

¹⁾ I-OPA-F outputs broad bandwidth pulses which are compressed externally.

²⁾ Output pulse duration depends on wavelength and pump laser pulse duration.
I-OPA-F requires pulse compressors to achieve short pulse duration.

³⁾ Up to 16 μ m tuning range is accessible with external Difference Frequency Generator.

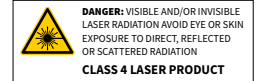

Fixed wavelength I-OPA in comparison to tunable version or standard ORPHEUS line devices lacks only computer-controlled wavelength selection. On the other hand, in-laser mounted design provides mechanical stability and eliminates the effects of air-turbulence ensuring stable long-term performance and minimizing energy fluctuations.



Fixed wavelength I-OPA-FW module attached to PHAROS

SPECIFICATIONS OF FIXED WAVELENGTH I-OPA

Model	I-OPA-FW-HP	I-OPA-FW-F	I-OPA-FW-ONE
Pump power		Up to 40 W	
Pump pulse energy	10 – 500 μ J	10 – 500 μ J	20 – 1000 μ J
Pulse repetition rate		Up to 2 MHz	
Wavelength range, signal	640 – 1010 nm	650 – 900 nm	1350 – 2060 nm
Wavelength range, idler	1050 – 2600 nm	1200 – 2500 nm	2060 – 4500 nm
Conversion efficiency at peak, signal wavelength	>7 % @ 700 nm	>7 % @ 700 nm	> 9 % @ 1550 nm
Pulse bandwidth ¹⁾	80 – 220 cm^{-1} @ 700 – 960 nm	200 – 750 cm^{-1} @ 650 – 900 nm 150 – 500 cm^{-1} @ 1200 – 2000 nm	60 – 150 cm^{-1} @ 1450 – 2000 nm
Pulse duration ²⁾	120 – 250 fs	< 55 fs @ 800 – 900 nm < 70 fs @ 650 – 800 nm < 100 fs @ 1200 – 2000 nm	150 – 300 fs
Applications	Micro-machining Microscopy Spectroscopy	Nonlinear microscopy Ultrafast spectroscopy	Micro-machining Mid-IR generation

¹⁾ I-OPA-F outputs broad bandwidth pulses which are compressed externally.

²⁾ Output pulse duration depends on wavelength and pump laser pulse duration. I-OPA-F requires external pulse compressors to achieve short pulse duration.

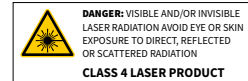

COMPARISON WITH OTHER FEMTOSECOND AND PICOSECOND LASERS

Laser technology	Our solution	HG or HIRO	I-OPA-FW-F	I-OPA-FW-ONE
Pulse energy at 100 kHz, using PHAROS-10W laser				
Excimer laser (193 nm, 213 nm)	5H of PHAROS (205 nm)	5 μ J	n/a	n/a
TH of Ti:Sa (266 nm)	4H of PHAROS (257 nm)	10 μ J		
TH of Nd:YAG (355 nm)	3H of PHAROS (343 nm)	25 μ J		
SH of Nd:YAG (532 nm)	2H of PHAROS (515 nm)	50 μ J	35 μ J	
Ti:Sapphire (800 nm)	OPA output (750 – 850 nm)	n/a	10 μ J	
Nd:YAG (1064 nm)	PHAROS output (1030 nm)		100 μ J	
Cr:Forsterite (1240 nm)	OPA output (1200 – 1300 nm)	n/a	5 μ J	n/a
Erbium (1560 nm)	OPA output (1500 – 1600 nm)		3 μ J	15 μ J
Thulium / Holmium (1.95 – 2.15 μ m)	OPA output (1900 – 2200 nm)		2 μ J	10 μ J
Other sources (2.5 – 4.0 μ m)	OPA output			1 – 5 μ J

Note that the pulse energy scales linearly in a broad range of pump parameters. For example, a PHAROS PH1-20 laser at 50 kHz (400 μ J energy) will increase the output power twice, and the pulse energy 4 times compared to the reference table above. The pulse duration at the output is <300 fs in all cases. The OPA output is not limited to these particular ranges of operation, it is continuously tunable as shown in energy conversion curves.

OUTLINE DRAWINGS

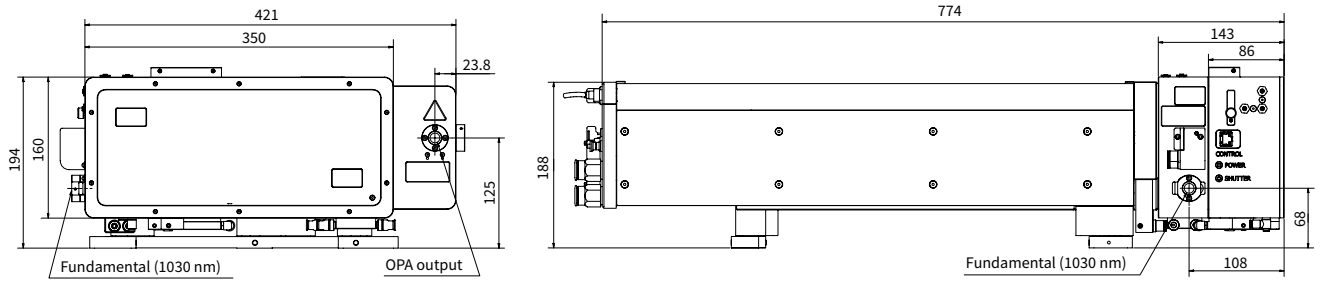

Outline drawing and output ports of CARBIDE-CB3 with tunable I-OPA-TW-HP

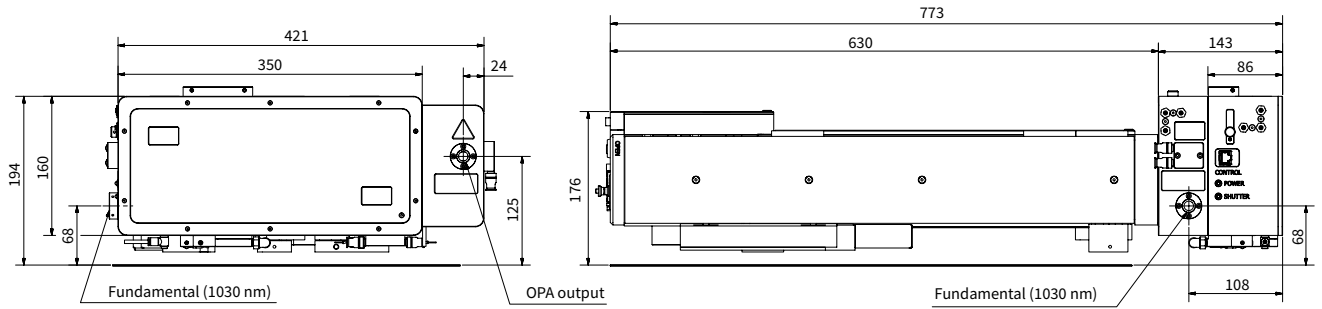

Outline drawing and output ports of CARBIDE-CB5 with tunable I-OPA-TW-HP

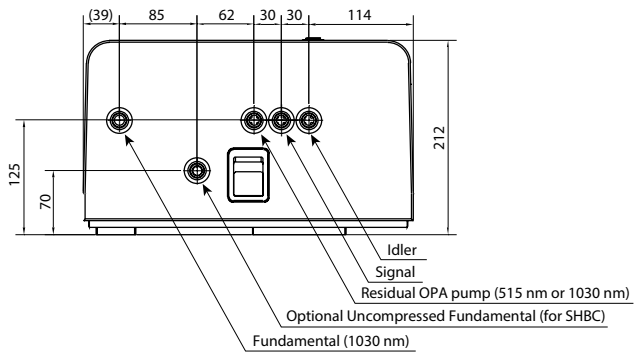

Output ports of PHAROS with fixed wavelength I-OPA-FW

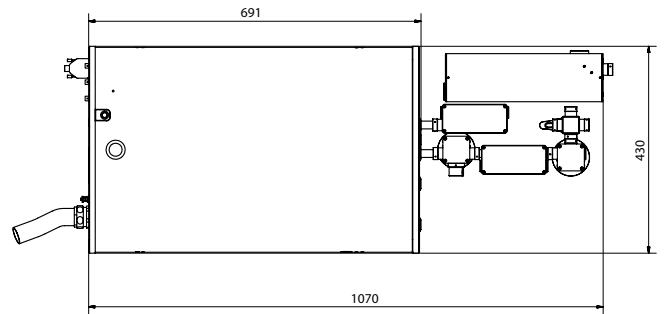

PHAROS with fixed wavelength I-OPA-FW-F and compressors for signal and idler